

BRANDVAN
® **EGMOND**



EDITION 30

Brand van Egmond

Every year we at BRAND VAN EGMOND strive to use all our knowledge and experience in order to create some of the most astounding lighting sculptures.

We are constantly inspired by the world around us, the people we meet and the beautiful projects we are invited to be part of. In return, we are frequently asked to translate unique lighting wishes into handcrafted reality. Partners like Louis Vuitton, Chopard and the Four Seasons Hotels invited BRAND VAN EGMOND to create tailor-made lighting solutions for their spaces. We welcome everybody who wants to see our designs, or would like personal advice from William Brand and his team, to our office and ateliers in Naarden, The Netherlands.

WILLIAM BRAND
BRAND VAN EGMOND TEAM

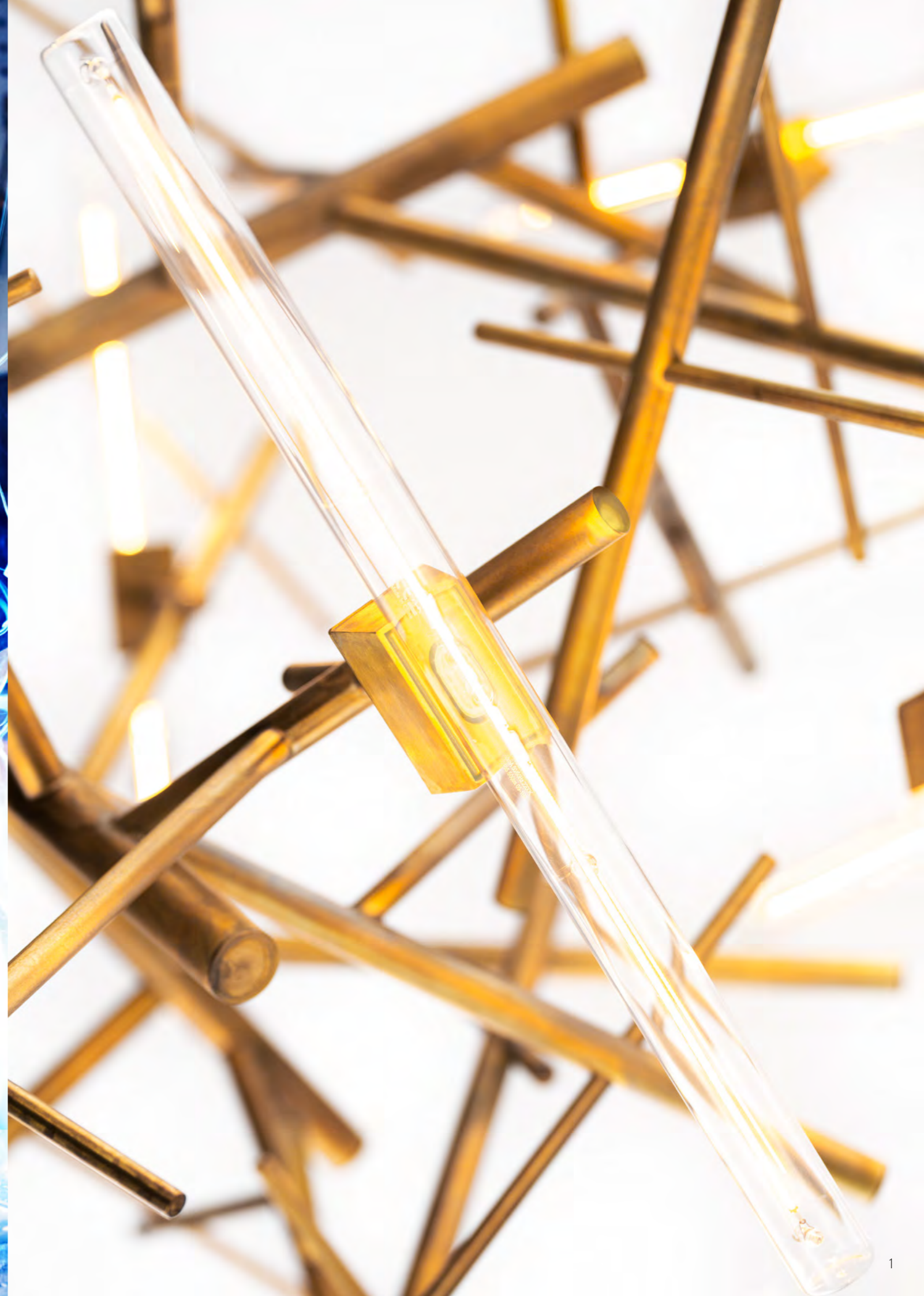

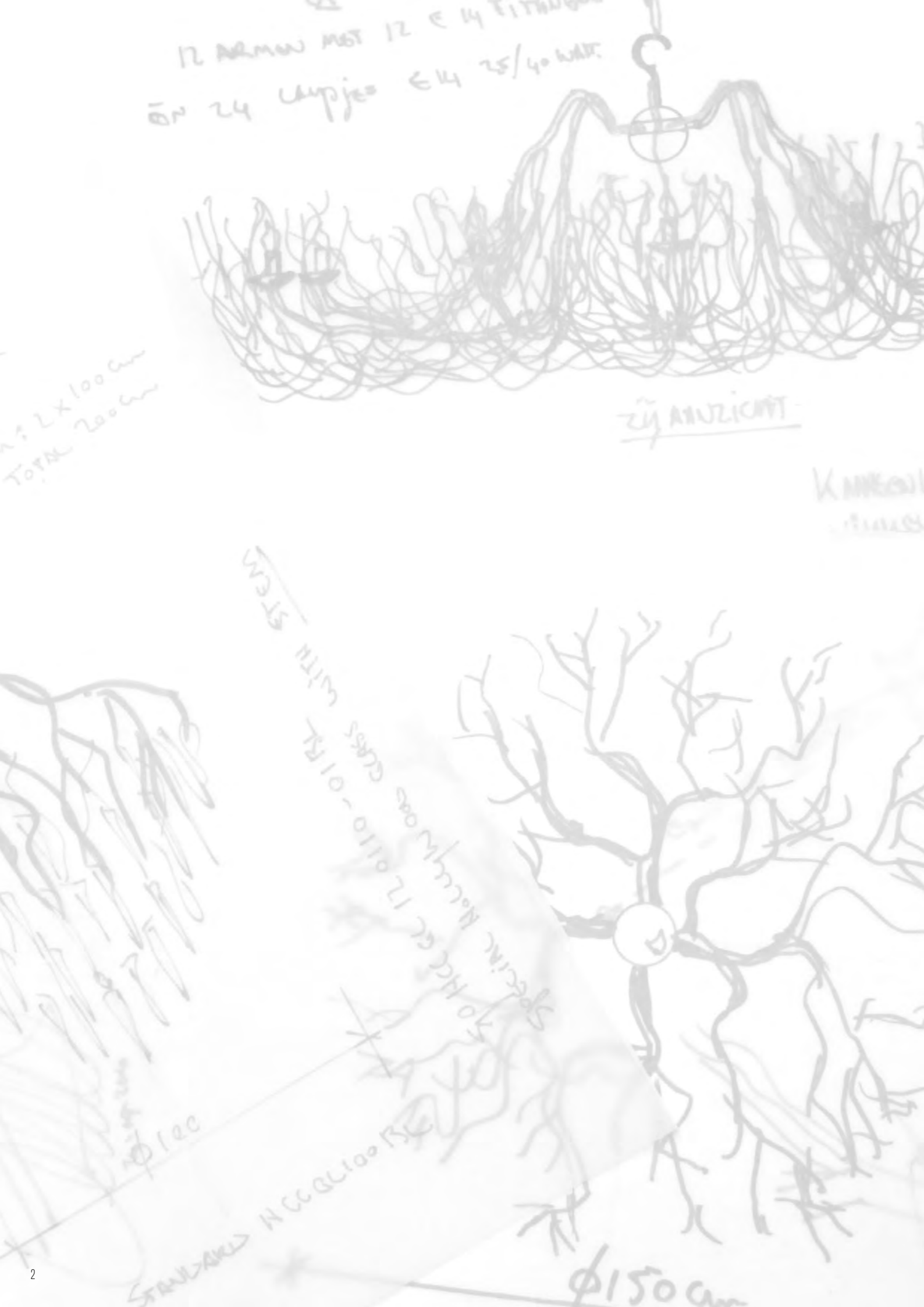

Welcome...

Every year we at BRAND VAN EGMOND strive to use all our knowledge and experience in order to create some of the most astonishing lighting sculptures.















We are constantly inspired by the world around us, the people we meet and the beautiful projects we are invited to be part of. In return, we are frequently asked to translate unique lighting wishes into handcrafted reality.











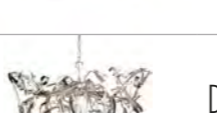

Partners like Louis Vuitton, Chopard and the Four Seasons Hotels invited us to create tailor-made lighting for their spaces.

We welcome everybody who wants to see our designs, or would like personal advice from William Brand and his team, to our office and atelier in Naarden, The Netherlands.

www.brandvanegmond.com

Content

	BRAND VAN EGMOND-HEADQUARTERS	6
	LINEA	10
	GALAXY	24
	ORPHEUS	34
	LOUISE	40
	ERSA	56
	SHIRO	84
	EVE	92
	FRACTAL	102
	FLINTSTONE	116
	KELP	120
	ARTHUR	138
	VICTORIA	146
	SULTANS OF SWING	154

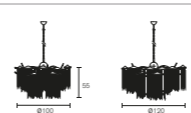
	LA VIE EN ROSE	168
	LOVE YOU LOVE YOU NOT	174
	FLOWER POWER	182
	ICY LADY	186
	CRYSTAL WATERS	192
	DELPHINIUM	200
	HOLLYWOOD	208
	HOLLYWOOD GLASS	228
	CUSTOMISED LIGHTING SCULPTURES	240
	EVERGREENS (COLLECTIONS THAT ARE NO LONGER IN REGULAR PRODUCTION)	254
	OPTIONAL FINISHES	258
	FOUNDER AND DESIGNER WILLIAM BRAND	260
	CERTIFICATE	262
	TECHNICAL INFO	264

BRAND VAN EGMOND

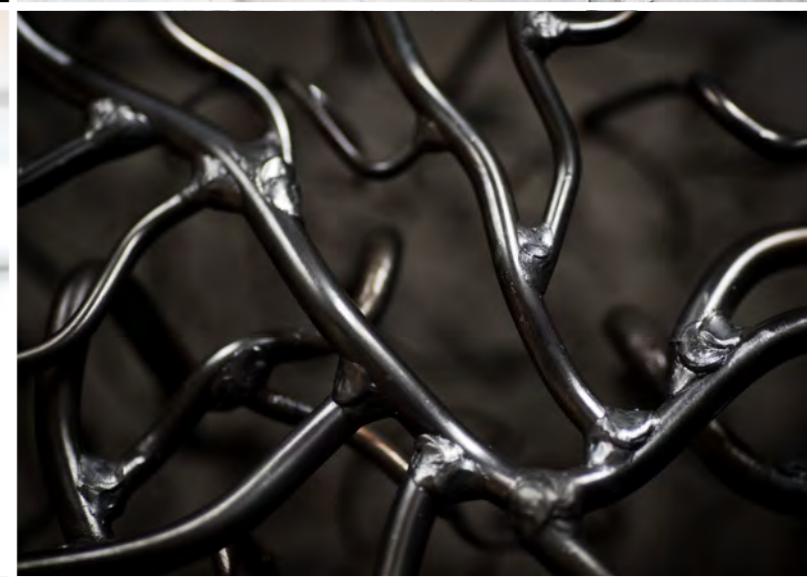
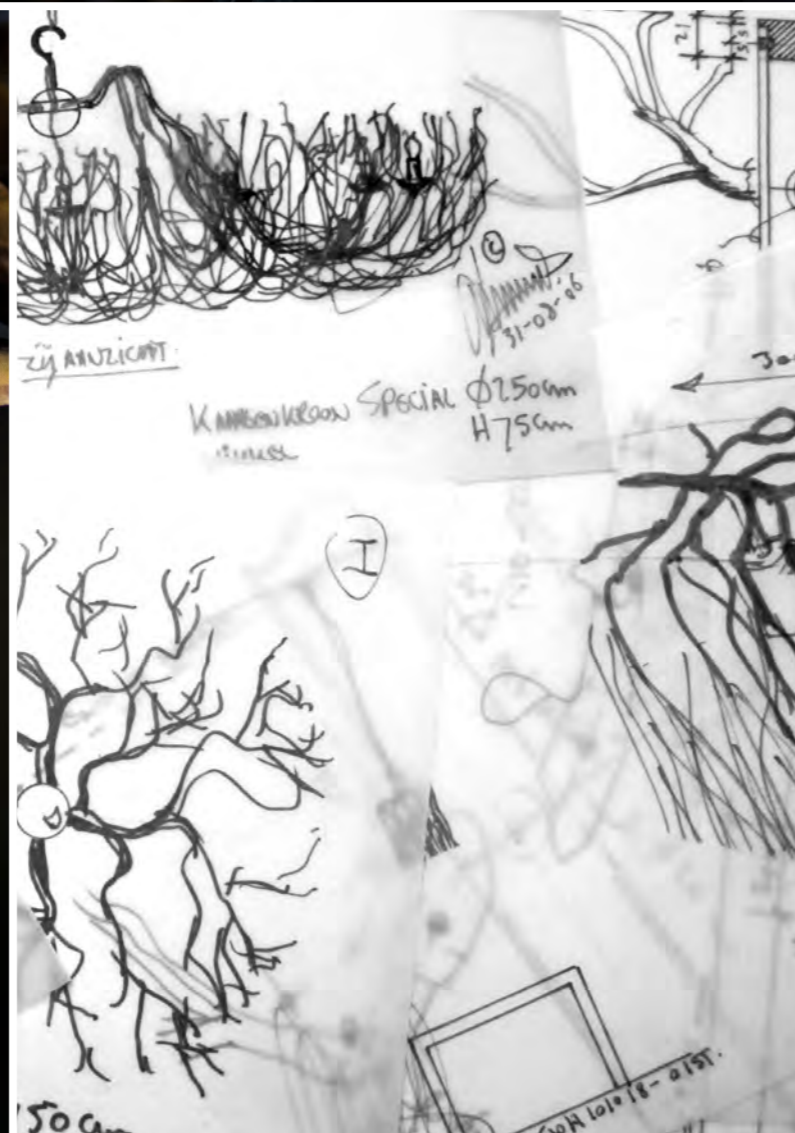
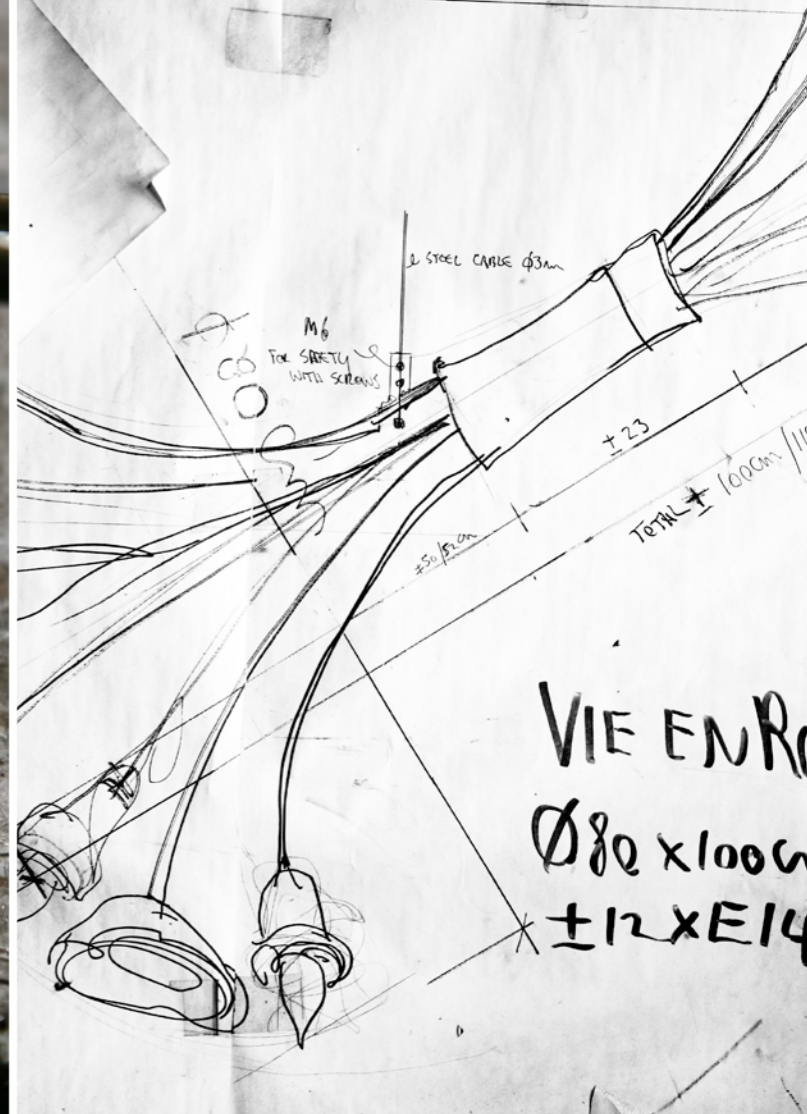

Brand van Egmond headquarters

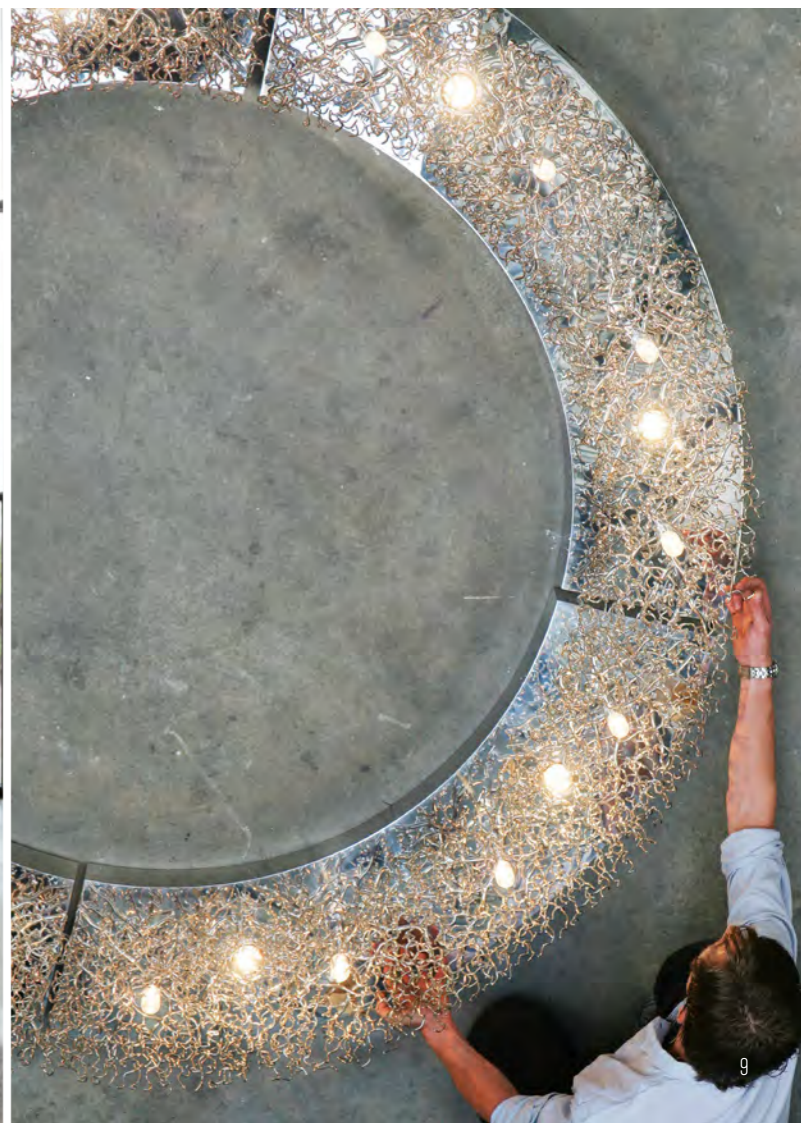

Linea

Design by William Brand

Truthful and pure, the Linea makes a precise yet playful statement through thin lines of beauty.

Floating through the sky, as if a magical formula brought to a standstill the whirlwind of steel, fire and light.

Frozen, both in time as well as in space.

Just like airplanes can leave a composition of line-shaped clouds -the passing proof of human movement in the air- the Linea is like a drawing of illuminating lines in the sky. Temporarily mid-air, permanently illuminating.

Creating a beautiful light is like good architecture: a matter of proportions.



LINC100BRBUR

Chandelier Round

(Ø100xH.70cm, brass burnished finish, 7 x S14D, 25.0kg)

Technical details page 264



LINW60BRBUR

Wall Lamp

(L.12xW.12xH.60 cm, brass burnished finish, 1 x S14D, 4.0kg)

Technical details page 265

LINC100BRBUR

Chandelier Round

(Ø100xH.70cm, brass burnished finish, 7 x S14D, 25.0kg)

Technical details page 264



LINC100BLM-BARST

Chandelier Round
(Ø100xH.70cm, black matt finish, 7 x S14D, 25.0kg)
Technical details page 264



LINC100BLM-BARST

Chandelier Round
(Ø100xH.70cm, black matt finish, 7 x S14D, 25.0kg)
Technical details page 264



LINLT50/70BLM and LINLT50/70BR
Composition of 7 Linea Elements
(Ø70xH.70cm, black matt and brass finish, 5 x S14D, 6.0kg)
Technical details page 265



LINLT50/70BLM
Linea Element
(Ø70xH.70cm, black matt finish, 5 x S14D, 6.0kg)
Technical details page 265



LINLT50/70BR and LINLTDL50/70BR

Composition of 2 Linea Elements and 3 Linea Elements with downlight

(Ø70xH.70cm, brass finish, 5 x S14D, 6.0kg and Ø70xH.70cm, brass finish, 5 x S14D, 1x GU10 spot downlight, 8.0kg)

Technical details page 265



LINLT50/70BR

Linea Element

(Ø70xH.70cm, brass finish, 5 x S14D, 6.0kg)

Technical details page 265



LINLT50/70BLM
Linea Elements
(Ø70xH.70cm, black matt finish, 5 x S14D, 6.0kg)
Technical details page 265



LINLTDL50/70BLM
Composition of 3 Linea Elements with downlight
(Ø70xH.70cm, black matt finish, 5 x S14D, 1x GU10 spot downlight, 8.0kg)
Technical details page 265



LINHL140BLM-BARBR

Linea Hanging Lamp Long

(L140xW.60xH.70cm, black matt finish, brass reflector bars, 5 x S14D, 3x GU10 spot downlight, 40.0 kg)

Technical details page 266



LINHL140BLM-BARBR

Linea Hanging Lamp Long

(L140xW.60xH.70cm, black matt finish, brass reflector bars, 5 x S14D, 3x GU10 spot downlight, 40.0 kg)

Technical details page 266

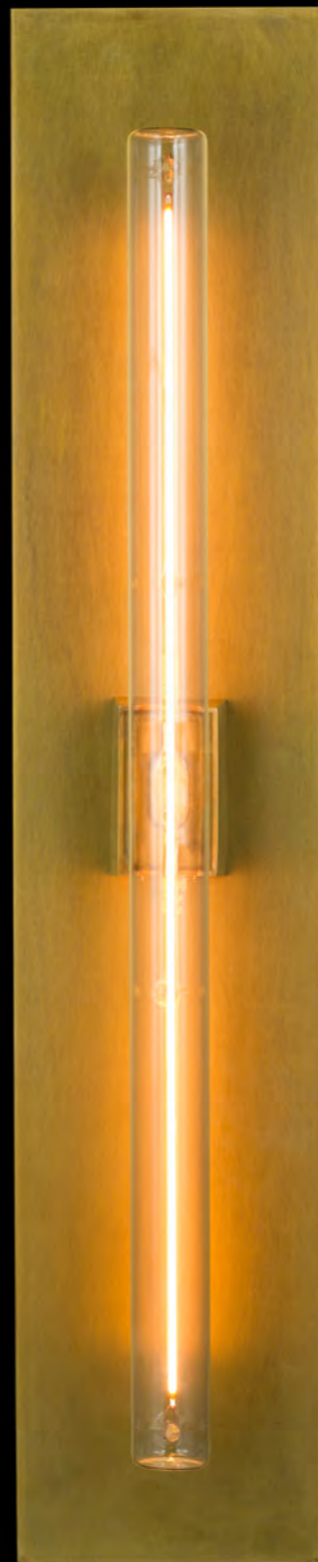

LINW60BRBUR

Linea Wall Lamp

(L.12xW.12xH.60 cm, brass burnished finish, 1 x S14D, 4.0kg)

Technical details page 265



LINW60NA

Linea Wall Lamp

(L.12xW.12xH.60 cm, nickel aged finish, 1 x S14D, 4.0kg)

Technical details page 265



Galaxy

Design by William Brand

The Galaxy is a constellation of energy, movement and form. Propelling away from the centre of gravity towards clouds of stardust and outer planets.

Avant-Garde by nature, the shapes and forms of the Galaxy relate to each other as the planets towards the sun. The artist and the dreamer both know, space is where an image grows.

The new collection Galaxy fell into the 21st century without a trace of regret from a different era, lightyears away. A lasting design has to have roots.



GALC100BR
Galaxy Chandelier Round
(Ø90xH.110 cm, brass finish, 5 x E27, 17.0kg)
Technical details page 268



GALC100BR
Galaxy Chandelier Round
(Ø90xH.110 cm, brass finish, 5 x E27, 17.0kg)
Technical details page 268



GALC100BR
Composition of 9 Galaxy Chandelier Round
(Ø90xH.110 cm, Brass finish, 5 x E27, 17.0kg)
Technical details page 268



GALC80BRBUR

Composition of 2 Galaxy Chandelier Round
(Ø80xH.70 cm, brass burnished finish, 3 x E27, 12.0kg)
Technical details page 268



GALC80BRBUR

Galaxy Chandelier Round
(Ø80xH.70 cm, brass burnished finish, 3 x E27, 12.0kg)
Technical details page 268

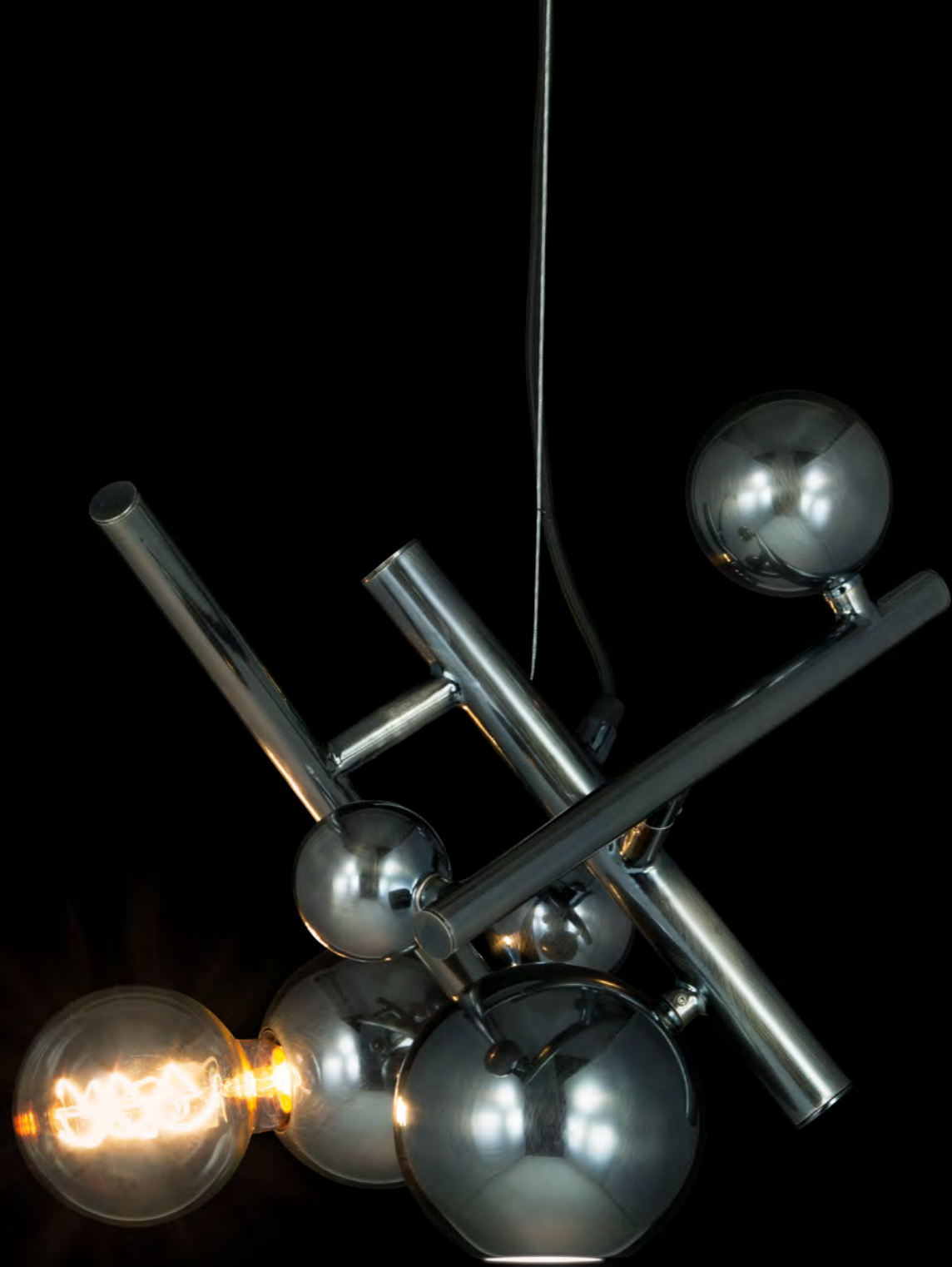

GALDL45NA

Galaxy Element

(L.40xW.45xH.50 cm, nickel aged finish, 1x GU10 spot downlight, 1 x E27, 5.0kg)

Technical details page 269



GALDL45NA

3 Galaxy Elements In line

(L.40xW.45xH.50 cm, nickel aged finish, 1x GU10 spot downlight, 1 x E27, 5.0kg)

Technical details page 269



GALHL140BLM-LGBR

Galaxy Hanging Lamp Long

(L.140xW.50xH.40 cm, black matt finish, light globes in brass finish, 3x GU10 spot downlight, 3 x E27, 15.0kg)

Technical details page 270



GALHL140BRBUR-LGBR

Galaxy Hanging Lamp Long

(L.140xW.50xH.40 cm, brass burnished finish, light globes in brass finish, 3x GU10 spot downlight, 4 x E27, 15.0kg)

Technical details page 270

Orpheus

Design by William Brand

One of the most legendary poets and singers in Greek mythology is Orpheus. He sang so beautifully that he touched everyone and all around him. The King and Queen were moved to tears, but also the birds, trees and even the stones were hypnotized by his magical voice.

We have found several objects of desire amidst the nymphs and trees, and formed them into new lights. A precious stone, a golden mineral and a delicate porcelain rose: all captured in a protective embrace of casted bronze.



Orpheus- Nymphenburg

The handcrafted rose is from Porzellan Manufaktur Nymphenburg, creating the finest porcelain for over 260 years. Crafted on the Nymphenburg palace grounds outside Munich, their handcrafted porcelain has been treasured by aristocracy and collectors from around the world



ORC35BDP-NYMR

2xOrpheus- Nymphenburg Art Element Limited Edition

(Ø35xH.85 cm, cast bronze dark patina finish with Nymphenburg Handmade Rose, 1x GU10, 4kg)

Technical details page 272



Orpheus-Pyrite

An astonishing mineral, seemingly made by human hands but in fact found in nature, is called Pyrite. Given its strong resemblance to gold, it was nicknamed by gold diggers as 'fool's gold'. The surfaces reflect the light in a fabulous way; creating a splendour of golden light.

Orpheus-Amethyst

This precious stone, embraced through the millennia by ancient Greeks, Russian Tsars and English bishops is seen as a protector against dark magic, and a symbol for those in love.

Due to the scarcity of (semi)precious stones and minerals, we need to check availability before an order can be confirmed. All (semi)precious stones differ from each other in size and shape.



Composition of ORC35BDP

4xOrpheus-Amethyst and 3xOrpheus-Pyrite Art Elements in line
 (Ø35xH.85 cm, cast bronze dark patina finish with amethyst or pyrite, 1x GU10, 4kg)
 Technical details page 272



ORC35BDP-PYR

Orpheus-Pyrite Art Element
 (Ø35xH.85 cm, cast bronze dark patina finish with Pyrite, 1x GU10, 4kg)
 Technical details page 272



ORC35BDP-AM

Orpheus-Amethyst Art Element
 (Ø35xH.85 cm, cast bronze dark patina finish with Amethyst, 1x GU10, 4kg)
 Technical details page 272



5xORC35BDP-AM

Composition of 5 Orpheus-Amethyst Art Elements Vertical
(Ø35xH.85 cm, cast bronze dark patina finish, 1x GU10, 4kg)
Technical details page 272



OR30-CANDBRBUR

Orpheus Element
(Ø30xH.57 cm, 1x E14, brass aged finish, 1x GU10 spot downlight, 3kg)
Technical details page 272

Louise

Design by William Brand

With almost carefree delight, William designed this Louise collection: A simple frame, decorated in a pleasing rhythm with glass lanterns.

A hint of chaos, never far away in designs from William Brand, is present: the different colours and positions of the glass lanterns have a joyful effect.

The frame is available in nickel aged, black matt, copper burnished and the lanterns in 4 different types of glass: bronze, clear satin, grey and iridescent.



LO4BRBUR - STANDARD

Standard Louise Hanging lamp in brass burnished finish with a bronze, clear satin, grey and iridescent glass lantern (Ø60xH.78cm, brass burnished finish, 1x GLL0BRO22, 1x GLL0GREY22, 1x GLL0SAT22, 1x GLL0IRI22, 4 x E27, 14.0kg)
Technical details page 273



LO3BRBUR - STANDARD

Standard Louise Hanging lamp in brass burnished finish with a clear satin, grey and iridescent glass lantern (Ø60xH.70cm, brass burnished finish, 1x GLL0GREY22, 1x GLL0IRI22, 1x GLL0SAT22, 3 x E27, 11.5kg)
Technical details page 273



LO4BRBUR - STANDARD

Standard Louise Hanging lamp in brass burnished finish with a bronze, clear satin, grey and iridescent glass lantern
(Ø60xH.78cm, brass burnished finish, 1x GLLOBRO22 ,1x GLLOGREY22,1x GLLOSAT22, 1x GLLIIRI22, 4 x E27, 14.0kg)
Technical details page 273



LO5BRBUR - STANDARD

Standard Louise Hanging lamp in brass burnished finish with a bronze, clear satin, grey and iridescent glass lantern
(Ø60xH.105cm, brass burnished finish, 1x GLLOBRO22 ,1x GLLOGREY22, 2x GLLOSAT22, 1x GLLIIRI22, 5 x E27, 18.0kg)
Technical details page 274



LO8BRBUR - STANDARD

Standard Louise Hanging lamp in brass burnished finish with a bronze, clear satin, grey and iridescent glass lantern
(Ø60xH.205cm, brass burnished finish, 2x GLOBRO22, 2x GLOGREY22, 2x GLOSAT22, 2x GLOIRI22, 8 x E27, 28.0kg)
Technical details page 274





LOC80BRBUR-STANDARD

Standard Louise Chandelier Round in brass burnished finish with a bronze, clear satin, grey and iridescent glass lantern (Ø82xH.53 cm, brass burnished finish, 3x GLOBRO22 ,1x GLOGREY22,1x GLOSAT22, 2x GLOIRI22, 7 x E27, 25.0kg)
 Technical details page 275



LOC80BRBUR-STANDARD

Standard Louise Chandelier Round in brass burnished finish with a bronze, clear satin, grey and iridescent glass lantern (Ø82xH.53 cm, brass burnished finish, 3x GLOBRO22 ,1x GLOGREY22,1x GLOSAT22, 2x GLOIRI22, 7 x E27, 25.0kg)
 Technical details page 275

LOF200BRBUR-STANDARD

Standard Floor Lamp in brass grinded finish with a bronze, clear satin and iridescent glass lantern (Ø50xH.202 cm, brass grinded finish, 1x GLOBRO22, 1x GLOSAT22, 1x GLOIRI22, 3 x E27, 16.0kg)
 Technical details page 278



Customised LOHL140BR

Customised Hanging Lamp Long in brass finish with 10 iridescent glass lanterns
(L.140xW.55xH.62 cm, brass finish, 10x GLLOIRI22, 10 x E27, 22.0kg)

Technical details page 276



LOHL140BRBUR-STANDARD

Standard Hanging Lamp Long in brass burnished finish with bronze, clear satin, grey and iridescent glass lantern
(L.140xW.55xH.62 cm, brass burnished finish, 3x GLLOBRO22 ,2x GLLLOGREY22, 2x GLLLOSAT22, 3x GLLLOIRI22,)

Technical details page 276



LO1BRBUR-GLLOSAT22

Louise Hanging lamp in brass burnished finish, clear satin glass lantern
(Ø60xH.36cm, brass burnished finish, 1x GLLOSAT22, 1 x E27, 2.4kg)
Technical details page 273



LO1BRBUR-GLLOGREY22

Louise Hanging lamp in brass burnished finish, grey glass lantern
(Ø22xH.36cm, brass burnished finish, 1x GLLOGREY22, 1 x E27, 2.4kg)
Technical details page 273



LO1BRBUR-GLOBRO22

Louise Hanging lamp in brass burnished finish, bronze glass lantern
(Ø22xH.36cm, brass burnished finish, 1x GLOBRO22, 1 x E27, 2.4kg)
Technical details page 273



LO1BRBUR-GLLOIRI22

Louise Hanging lamp in brass burnished finish, iridescent glass lantern
(Ø22xH.36cm, brass burnished finish, 1x GLLOIRI22, 1 x E27, 2.4kg)
Technical details page 273



LO1BRBUR-GLLOSAT22

Louise Hanging lamp in brass burnished finish, clear satin glass lantern
(Ø22xH.36cm, brass burnished finish, 1x GLLOSAT22, 1 x E27, 2.4kg)
Technical details page 273



SPLOF180COPBUR

Customised Louise Floor Lamp in copper burnished finish with an iridescent glass lantern

(Ø30xH.182 cm, copper burnished finish, 1x GLLOIRI22, 1 x E27, 11.0kg)

Technical details page 278



LOT75BRBUR-GLLOBRO22

Louise Table Lamp in brass burnished finish with a Bronze glass lantern

(L.35xW.22xH.76 cm, brass burnished finish, 1x GLLOBRO22, 1 x E27, 8.0kg)

Technical details page 279



LOT75NA-GLLOGREY22

Louise Table Lamp in nickel aged finish with a Grey glass lantern

(L.35xW.22xH.76 cm, nickel aged finish, 1x GLLLOGREY22, 1 x E27, 8.0kg)

Technical details page 279



LOP60BRBUR-STANDARD

Standard Louise Ceiling Lamp Round in brass burnished finish with a bronze, grey and iridescent glass lantern (Ø60xH.50 cm, brass burnished finish, 1x GLLOBRO22 ,1x GLLOGREY22, 1x GLLIIRI22, 3 x E27, 10.0kg)
 Technical details page 277



LOP60NA-STANDARD

Standard Louise Ceiling Lamp Round in nickel aged finish with a clear satin, grey and iridescent glass lantern (Ø60xH.50 cm, nickel aged finish, 1x GLLOSAT22 ,1x GLLOGREY22, 1x GLLIIRI22, 3 x E27, 10.0kg)
 Technical details page 277



LOW60BRBUR

Louise Wall Lamp in brass burnished finish with a grey glass lantern (L.22xW.30xH.58 cm, brass burnished finish, 1x GLLOGREY22, 1 x E27, 4.0kg)
 Technical details page 279



LOW60BRBUR

Louise Wall Lamp in brass burnished finish with a bronze glass lantern (L.22xW.30xH.58 cm, brass burnished finish, 1x GLLOBRO22, 1 x E27, 4.0kg)
 Technical details page 279



LOW60BRBUR

Louise Wall Lamp in brass burnished finish with an iridescent glass lantern (L.22xW.30xH.58 cm, brass burnished finish, 1x GLLIIRI22, 1 x E27, 4.0kg)
 Technical details page 279



LOW60BRBUR

Louise Wall Lamp in brass burnished finish with a clear satin glass lantern (L.22xW.30xH.58 cm, brass burnished finish, 1x GLLOSAT22, 1 x E27, 4.0kg)
 Technical details page 279

Ersa

Design by William Brand

A fresh breath of air whispers through the handcrafted branches of the Ersa. Capturing that brief moment of morning glory, when small drops of dew in nature can be found before disappearing in the air of a new born day.

Ersa derives her name from the ancient Greek's goddess of morning dew. Small dewdrops act as nature's perfume.



ERSAC100BRBUR-GLBRO

Ersa Chandelier Round with bronze translucent glass spheres
(Ø110x H.75 cm, brass burnished finish, 7 x E27, 23kg)

Technical details page 280



ERSAC100N-GLCLE

Ersa Chandelier Round with clear glass spheres
(Ø110x H.75 cm, nickel finish, 7 x E27, 23kg)

Technical details page 280



ERSAC120N-GLIRI
Ersa Chandelier Round with iridescent glass spheres
(Ø120xH.70 cm, nickel finish, 9 x E27, 32kg)
Technical details page 280



ERSAC120N-GLIRI
Ersa Chandelier Round with iridescent glass spheres
(Ø120xH.70 cm, nickel finish, 9 x E27, 32kg)
Technical details page 280



ERSAC100B-GLBRO

Ersa Chandelier Round with bronze translucent glass spheres
(Ø110x H.75 cm, bronze finish, 7 x E27, 23kg)
Technical details page 280



ERSAC80BRBUR-GLIRI

Ersa Chandelier Round with iridescent glass spheres
(Ø80xH.65 cm, brass burnished finish, 5 x E27, 15kg)
Technical details page 280



ERSA4BR-GLBRO

Ersa Chandelier Round with bronze translucent glass spheres
(L.80xW.55xH.50 cm, brass finish, 4 x E27, 11kg)
Technical details page 280



ERSAC80N-GLIRI

Ersa Chandelier Round with iridescent glass spheres
(Ø80xH.65 cm, nickel finish, 5 x E27, 15kg)
Technical details page 280



ERSACC90N-GLIRI

Ersa Chandelier Conical with iridescent glass spheres.
(Ø90xH.120 cm, nickel finish, 9 x E27, 35kg)
Technical details page 282



ERSACC90N-GLIRI

Ersa Chandelier Conical with iridescent glass spheres.
(Ø90xH.120 cm, nickel finish, 9 x E27, 35kg)
Technical details page 282



ERSAOC140BRBUR-GLIRI

Ersa Chandelier Oval with iridescent glass spheres
(L.140xW.60xH.70 cm, brass burnished finish, 7 x E27, 20kg)
Technical details page 283



ERSAOC140BRBUR-GLIRI

Ersa Chandelier Oval with iridescent glass spheres
(L.140xW.60xH.70 cm, brass burnished finish, 7 x E27, 20kg)
Technical details page 283



ERSAV110N-GLCLE

Ersa Suspension Vertical with clear glass spheres
(Ø60xH.110 cm, nickel finish, 5 x E27, 15kg)
Technical details page 285



ERSAV110BR-GLIRI

Composition of 2 ERSAV110BR-GLIRI with iridescent glass spheres
(Ø60xH.110 cm, brass finish, 5 x E27, 15kg)
Technical details page 285





ERSAV130BRBUR-GLIRI

Ersa Suspension Vertical with iridescent glass spheres.
(Ø90xH.130 cm, brass burnished finish, 8 x E27, 25kg)
Technical details page 285



ERSAV130BRBUR-GLIRI

Ersa Suspension Vertical with iridescent glass spheres.
(Ø90xH.130 cm, brass burnished finish, 8 x E27, 25kg)
Technical details page 285



ERSAHL150N-GLCLE

Ersa Hanging Lamp Long with clear glass spheres
(L.155xW.45xH.35 cm, nickel finish, 5 x E27, 15kg)
Technical details page 286



ERSAHL150N-GLCLE

Ersa Hanging Lamp Long with clear glass spheres
(L.155xW.45xH.35 cm, nickel finish, 5 x E27, 15kg)
Technical details page 286



ERSA3BRBUR-GLBRO

Ersa Element with bronze translucent glass spheres,
(L 65cm, H 60cm, D 55cm, brass burnished finish, 3 x E27, 10kg)
Technical details page 289



COMPOSITION OF 3X Ersa2BR-GLIRI

Ersa Elements with iridescent glass spheres
(L 60cm, H 60cm, D 55cm, brass finish, 2 x E27, 8kg)
Technical details page 289



COMPOSITION OF 4X ERS1BLM-GLIRI

4 Ersa Elements Inline with iridescent glass sphere
(L 30cm, H 50cm, D 30cm, black matt finish, 1 x E27, 6kg)
Technical details page 289



ERS1BLM-GLIRI

Ersa Element with iridescent glass sphere
(L 30cm, H 50cm, D 30cm, black matt finish, 1 x E27, 6kg)
Technical details page 289



ERSACP80BRBUR-GLBRO

Ersa Ceiling Chandelier with bronze translucent glass spheres
(Ø80xH.65 cm, brass burnished finish, 5 x E27, 13kg)
Technical details page 287



ERSACP80BRBUR-GLBRO

Ersa Ceiling Chandelier with bronze translucent glass spheres
(Ø80xH.65 cm, brass burnished finish, 5 x E27, 13kg)
Technical details page 287



ERSAP60BR-GLBRO

Ersa Ceiling Lamp Round with bronze translucent glass spheres
(Ø60xH.25 cm, brass finish, 3 x E27, 10kg)
Technical details page 286



ERSAP60N-GLIRI

Ersa Ceiling Lamp Round with iridescent glass spheres
(Ø60xH.25 cm, nickel finish, 3 x E27, 10kg)
Technical details page 286



ERSAW30N-GLCLE

Ersa Wall Lamp with clear glass sphere
(W.30xH.45xD.29 cm, nickel finish, 1 x E27, 4kg)
Technical details page 286

ERSAHL150N-GLCLE

Ersa Hanging Lamp Long with clear glass spheres
(L.155xW.45xH.35 cm, nickel finish, 5 x E27, 15kg)
Technical details page 288



ERSAF200N-GLIRI

Ersa Floor Lamp with iridescent glass spheres
(Ø40xH.205cm, nickel finish, 3 x E27, 24kg)
Technical details page 287



ERSAF200BRBUR-GLBRO

Ersa Floor Lamp with bronze translucent glass spheres
(Ø40xH.205cm, brass burnished finish, 3 x E27, 24kg)
Technical details page 287

Shiro

Design by William Brand

By means of the deduction of every unnecessary layer of decoration, a calmness of mind appears allowing for a new collection to be born. The Shiro – Japanese for castle - is the result of a journey of deconstruction.

Stripped of all but the bare yet beautiful essentials, this new collection permits for a well composed equilibrium.

It allows serenity to triumph over chaos.



SHSR100BRBUR

Shiro Suspension Ring

(Ø 115cm, H 33cm, brass burnished finish, 18 x E14, 23kg)

Technical details page 290



SHSR100BRBUR

Shiro Suspension Ring

(Ø 115cm, H 33cm, brass burnished finish, 18 x E14, 23kg)

Technical details page 290



Customised SHSR160BRBUR

Customised Shiro Suspension Ring with Customised suspension
(Ø 175cm, H 33cm, brass burnished finish, 20 x E14, 50kg)



Customised SHSR160BRBUR

Customised Shiro Suspension Ring with Customised suspension
(Ø 175cm, H 33cm, brass burnished finish, 20 x E14, 50kg)



SHSV200BRBUR

Shiro Suspension Vertical

(Ø 22cm, H 210cm, brass burnished finish, 12 x E14, 1xGU10 downlight, 22kg)

Technical details page 291



COMPOSITION OF 2XSHSV70BRBUR

Shiro Suspension Vertical

(Ø 22cm, H 80cm, brass burnished finish, 6 x E14, 1xGU10 downlight 8kg)

Technical details page 291



SHSH150BRBUR

Shiro Suspension Horizontal

(L 150cm, H 33cm, W 25cm, brass burnished finish, 3x MR11 spot downlight, 12Volt, 14 x E14, 18kg)

Technical details page 290



SHW34BRBUR

Shiro Wall Lamp

(W.12xH.34xD.9 cm, brass burnished finish, 1 x E14, 2kg)

Technical details page 291



Eve

Design by William Brand

To be human, is to be aware that there are forces greater than ourselves. From the majestic power of nature, until the longings deep within our soul.

With an elegant twist, although with an undeniable force behind it, the new Eve is crafted. The fruit she carries is tempting.... will the apple be eaten, or not?



EVEOC140BR

Eve Chandelier Oval

(L.140xW.60xH.60cm, brass finish, 12 x E14, 16kg)

Technical details page 293



EVEC100N

Eve Chandelier Round

(Ø100xH.60cm, nickel finish, 14 x E14, 13kg)

Technical details page 294



Customised EVEC100COP

Customised Eve Chandelier Round

(Ø100xH.60cm, copper finish, 14 x E14, 13kg)

Technical details page 294



EVEC100BR

Eve Chandelier Round

(Ø100xH.60cm, brass finish, 14 x E14, 13kg)

Technical details page 294



Customised EVEC100COP

Customised Eve Chandelier Round

(Ø100xH.60cm, copper finish, 14 x E14, 13kg)

Technical details page 294



EVEOC140N

Eve Chandelier Oval

(L.140xW.60xH.60cm, nickel finish, 12 x E14, 16kg)

Technical details page 293



EVECC70BRBUR

Eve Chandelier Conical

(Ø70xH.80cm, brass burnished finish, 12 x E14, 16kg)

Technical details page 292



EVECC70B-LGBR

Eve Chandelier Conical

(Ø70xH.80cm, bronze finish with brass light globes, 12 x E14, 16kg)

Technical details page 292



EVECC70B-LGBR

Eve Chandelier Conical

(Ø70xH.80cm, bronze finish with brass light globes, 12 x E14, 16kg)

Technical details page 292

Fractal

Design by William Brand

Our brains are set up to bring order in chaos, find logic in confusion and recognise patterns in the opaque. However, what to make of the puzzle of the exact yet endless repetition found at times around us?

Fractal is a natural phenomenon as well as a mathematical set that exhibits a repeating pattern.

The organised chaos of the reflecting elements of the Fractal dispenses the light beautifully in all directions.

The finishes are stainless steel, brass grinded, black matt and white matt.



FRACC100BRG

Fractal Chandelier Round

(Ø 100cm, H 45cm, 12 x E14, brass grinded finish, 27 kg)

Technical details page 295



FRACC100BRG

Fractal Chandelier Round

(Ø 100cm, H 45cm, 12 x E14, brass grinded finish, 27 kg)

Technical details page 295



downlight

downlight

downlight

CUSTOMISED FRACTAL

Customised Fractal Chandelier Oval

(L.140xW.55xH.60 cm, brass grinded finish, 3x GU10 spot downlight, 12x E14, 50 kg)



FRACC100ST
Fractal Chandelier Round
(Ø 100cm, H 45cm, 12 x E14, stainless steel, 27 kg)
Technical details page 295



FRACC80BLM
Fractal Chandelier Round
(Ø 80cm, H 35cm, 10 x E14, black matt finish, 19 kg)
Technical details page 295





FRACP60BLM
Fractal Ceiling Lamp Round
(Ø60xH.30 cm, 8x E14, black matt finish, 15 kg)
Technical details page 295



FRACP80ST
Fractal Ceiling Lamp Round
(Ø80xH.35 cm, 10x E14, stainless steel, 20 kg)
Technical details page 295



FRACP100MW
Fractal Ceiling Lamp Round
(Ø100xH.35 cm, 10x E14, white matt finish, 25 kg)
Technical details page 295

Fractal Cloud

Design by William Brand

Available in 55 cm and 70 cm, carrying 3 lights inside.

Finishes in stainless steel, brass grinded, black matt and white matt.



FRACHR55BRG

Fractal Cloud Hanging lamp

(Ø 55cm, H 60cm, 3 x E27, brass grinded finish, 13kg)

Technical details page 296



CUSTOMISED FRACHR55BR

Customised Fractal Cloud Hanging lamp
(Ø 55cm, H 60cm, 3 x E27, brass finish, 13kg)
Technical details page 296



FRACHR55BRG

Fractal Cloud Hanging lamp
(Ø 55cm, H 60cm, 3 x E27, brass grinded finish, 13kg)
Technical details page 296

FRACHR55BLM

Fractal Cloud Hanging lamp
(Ø 55cm, H 60cm, 3 x E27, black matt finish, 13kg)
Technical details page 296



FRACHR55ST

Fractal Cloud Hanging lamp
(Ø 55cm, H 60cm, 3 x E27, stainless steel, 13kg)
Technical details page 296



CUSTOMISED FRACTAL

Customised Fractal Chandelier Long
(L.200xW.50xH.50 cm, brass finish, 12 x E14, 55kg)



Flintstone

Design by William Brand

Retracing our steps through the millennia to the beginning of times, we find ourselves back at the fireplace in the prehistoric cave. Here we realise that the most primal of our needs are safety and warmth. The tree branch and the stone, found at the end of this journey back in time, are combined in this lighting object. Every stone is unique, and captures the emotion of eternity as well as being used as a functional counterweight.

The branch of the Flintstone is flexible, allowing the light to be adjusted and easily moved through space.

The length of the branch can be ordered in different sizes.

The finishes are either in black matt, white matt, nickel and brass burnished

Possible length of the branch is: 70 cm, 100 cm, 130 cm, 160 cm, 190 cm, 210 cm or 240 cm.



FLINTF160BRBUR

Flintstone floor lamp, L 160cm, W 40cm, H 235cm,
brass burnished finish, 1 x E27, 40kg
Technical details page 297



CUSTOMISED FLINTF70BLM

Customised Flintstone floor lamp, L 70cm, W 40cm, H 235cm, black matt finish, 1 x E27, 40kg,
Rock in 24K Gold Leaf finish can be ordered as special
Technical details page 297



FLINTF70N

Flintstone floor lamp, L 130cm, W 40cm, H 235cm, nickel finish, 1 x E27, 40kg
Technical details page 297

Kelp

Design by William Brand

Frivolous and light-hearted, spirited and energetic; the arched and curved KELP dances through the air. The light sparkles warmly as in a crackling open fire, bringing an exhilarating sense to any space.

Imagine yourself submerged in a vast tropical ocean, at awe with the unexpected colours and forms in this to you previously unknown world.

Dive one level deeper, and be amazed by the surprising beauty of organisms floating by.

As nature comes in many forms, the KELP can be ordered in different shapes and sizes. The possibilities are endless. Use the KELP elements in any variety you like, as a single object or a dancing composition by entwining various objects together.

100KELPCOP

Composition of 3 Kelp Elements
(L 80 cm, W 100 cm, H 80 cm, 5 x E14, copper finish, 15 kg)
Technical details page 302



100KELPCOP

Kelp Element
(L 80 cm, W 100 cm, H 80 cm, 5 x E14, copper finish, 15 kg)
Technical details page 302



100KELPCOP

Kelp Element

(L.80xW.100xH.80cm, 5x E14, copper finish, 15kg)

Technical details page 302



CUSTOMISED 100KELPCOP

Customised Kelp Element

(L.80xW.100xH.160 cm, 12 x E14, copper finish, 35 kg)



100KELPBLM
Kelp Element
(L.80xW.100xH.80cm 5x E14, black matt finish, 15kg)
Technical details page 302



100KELPBRA
Kelp Element
(L.80xW.100xH.80 cm, 5 x E14, brass aged finish, 15 kg)
Technical details page 302



3X100KELPBR

Composition of 3 Kelp 100 Elements

(L.150xW.150xH.150 cm, 10x E14, brass finish, 25kg)

Technical details page 302



100KELPBR

Kelp Element

(L 80 cm, W 100 cm, H 80 cm, 5 x E14, brass finish, 15 kg)

Technical details page 302



Composition of 25KELP inline

3x25KELPCOP and 2xKELPBLM-LGCOP Elements

Technical details page 302



25KELPCOP

Kelp Element

(L.25xW.25xH.35 cm, copper finish, 1 x E14, 1,5 kg)

Technical details page 302

50KELPBLM

Kelp Element

(L.40xW.40xH.50 cm, black matt finish, 1 x E14, 2 kg)

Technical details page 302



Customised 50KELPWM

Kelp Element

(L.40xW.40xH.50 cm, white matt finish, 1 x E14, 2 kg)

Technical details page 302



50KELPBRA

Kelp Element

(L.40xW.40xH.50 cm, brass aged finish, 1 x E14, 2 kg)

Technical details page 302



KELPCC80ST

Kelp Chandelier Conical

(Ø55xH.80 cm, stainless steel, 10 x E14, 30 kg)

Technical details page 298



KELPCC80BLM-LGBR

Kelp Chandelier Conical

(Ø55xH.80 cm, black matt with brass light globes, 10 x E14, 30 kg)

Technical details page 298



KELPOC140COP

Kelp Chandelier Oval

(L.140xW.60xH.55 cm, copper finish, 10 x E14, 30 kg)

Technical details page 299



Customised KELPC100WM

Kelp Chandelier Round

(Ø100xH.60 cm, white matt finish, 10 x E14, 40 kg)

Technical details page 300



KELPC100BR
Kelp Chandelier Round
(Ø100xH.60 cm, brass finish, 10 x E14, 40 kg)
Technical details page 300



KELPP80BRG
Kelp Ceiling Lamp
(Ø80xH.30 cm, brass grinded finish, 6 x E14, 15 kg)
Technical details page 301



KELPP80COP
Kelp Ceiling Lamp
(Ø80xH.30 cm, copper finish, 6 x E14, 15 kg)
Technical details page 301

Arthur

Design by William Brand

He emerges as a conqueror when the darkness is fenced off.

Proudly overlooking the arena where he reigns.

Behind his metal curtain he shines his light

guarding everyone around.

DE PAUWHOF RESIDENCE WASSENAAR, NL



ARCC70N

Arthur Chandelier Conical
(Ø80xH.100 cm, nickel finish, 14 x E14, 40 kg)

Technical details page 304



AROC140N

Arthur Chandelier Oval

(L.140xW.60xH.55 cm, nickel finish, 16 x E14, 36 kg)

Technical details page 304



ARC100N

Arthur Chandelier Round

(Ø100xH.55 cm, nickel finish, 14 x E14, 40 kg)

Technical details page 305



AR18N
Hanging Lamp Single
(Ø18xH.75 cm, nickel finish, 3 x E14, 10 kg)
Technical details page 305



10XCUSTOMISED AR18N
Composition 10x Customised AR18N Hanging Lamp Singles
(Ø35xH.150 cm, nickel finish, 5 x E14, 25 kg)

PRIVATE INTERIOR AMSTERDAM, NL FEATURING
INTERIOR DESIGN BY ROY DE SCHEEMAKER



ARP80N
Ceiling Lamp Round
(Ø80xH.45 cm, nickel finish, 6 x E14, 27 kg)
Technical details page 306



ARW50N
Wall Lamp
(W.20xH.50xD.12 cm, nickel finish, 1 x E14, 7 kg)
Technical details page 307



ART30N
Table Lamp
(Ø30xH.85 cm, nickel finish, 3 x E14, 17 kg)
Technical details page 306



ARF190N
Floor Lamp
(Ø30xH.190 cm, nickel finish, 5 x E14, 32 kg)
Technical details page 306

A close-up photograph showing a pair of hands using blue-handled pliers to carefully assemble a crystal chandelier component. The hands are positioned in the foreground, with the pliers gripping a small, faceted crystal piece. In the background, a large, dark metal component of the chandelier is visible, featuring a spring mechanism. The overall scene is set against a dark, blurred background, emphasizing the intricate work being performed.

Victoria

Design by William Brand

Before you see it, the sparkling light reaches your eyes in full splendour. The fresh ray of light enriches its surroundings and brings it to life.

Like a waterfall that blows droplets through the sky, a vapour of crystals comes down at you.



VCC70N

Victoria Chandelier Conical
(Ø70xH.80 cm, nickel finish, 12 x E14, 28 kg)
Technical details page 308



VOC160N

Victoria Chandelier Oval

(L.160xW.60xH.55 cm, nickel finish, 16 x E14, 26 kg)

Technical details page 308



VC100N

Victoria Chandelier Round

(Ø100xH.55 cm, nickel finish, 14x E14, 29 kg)

Technical details page 309





VC18N

Victoria Hanging Lamp Single
(Ø18xH.75 cm, nickel finish, 3 x E14, 7 kg)
Technical details page 309



3xVC18N

Composition of 3x VC18N Victoria Hanging Lamp Singles
(Ø18xH.75 cm, nickel finish, 3 x E14, 7 kg)
Technical details page 309



VP80N
Victoria Ceiling Lamp
(Ø80xH.45 cm, nickel finish, 6 x E14, 20 kg)
Technical details page 309



VW50N
Victoria Wall Lamp
(W.20xH.50xD.12 cm, nickel finish, 1 x E14, 5 kg)
Technical details page 310



VT30N
Victoria Table Lamp
(Ø30xH.85 cm, nickel finish, 3 x E14, 12 kg)
Technical details page 310

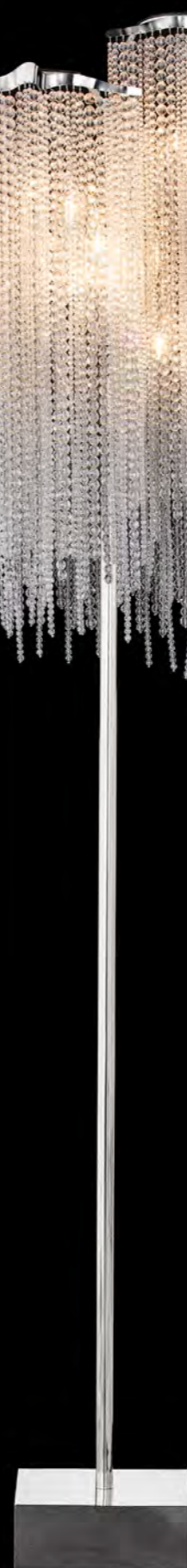

VF190N
Victoria Floor Lamp
(Ø30xH.190 cm, nickel finish, 5 x E14, 27 kg)
Technical details page 310

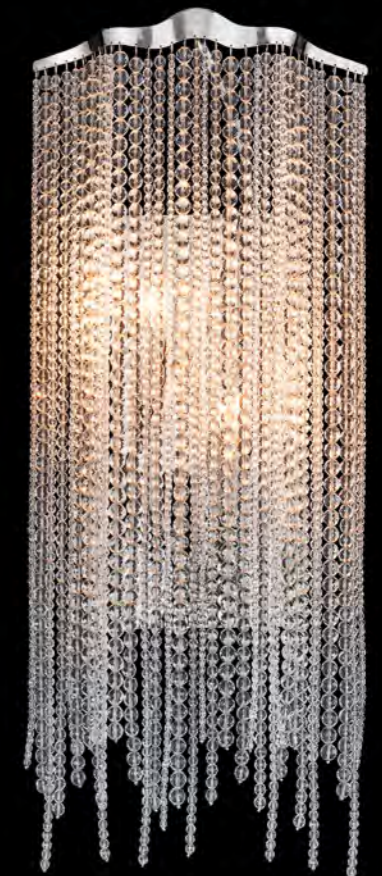

VW70N
Victoria Wall Lamp
(W.30xH.70xD.12 cm, nickel finish, 2 x E14, 8 kg)
Technical details page 310

Sultans of Swing

Design by William Brand

Beauty enables us to find and lose ourselves at the same time. Only when paying careful attention, we sometimes hear the quiet whispers of history from beyond the curtain of time. Embracing both times gone by as well as the present, Sultans of Swing captures Imperial elegance and the sheer pleasure of blowing new life into long-standing shapes and forms.

DESSANGE SALON Moscow, RU



SOSCC80N

Sultans Of Swing Chandelier Conical
(Ø80xH.100 cm, nickel finish, 14 x E14, 30 kg)

Technical details page 311



SOSC80N

Sultans Of Swing Chandelier Conical
(Ø80xH.100 cm, nickel finish, 14 x E14, 30 kg)
Technical details page 311



SOSOC140N

Sultans Of Swing Chandelier Oval
(L.140xW.70xH.55 cm, nickel finish, 14 x E14, 35 kg)
Technical details page 311



SOSC100N

Sultans Of Swing Chandelier Round
(Ø100xH.55 cm, nickel finish, 14 x E14, 38 kg)
Technical details page 312



SOSH140N

Sultans Of Swing Hanging Lamp
(L.140xW.40xH.55 cm, nickel finish, 6 x E14, 15 kg)
Technical details page 312



SOSP60N

Sultans Of Swing Ceiling Lamp
(Ø60xH.35 cm, nickel finish, 6 x E14, 10 kg)
Technical details page 313



SOSP80N

Sultans Of Swing Ceiling Lamp
(Ø80xH.35 cm, nickel finish, 8 x E14, 13 kg)
Technical details page 313



SOST65N

Sultans Of Swing Table Lamp
(Ø35xH.65 cm, nickel finish, 3 x E14, 10 kg)
Technical details page 313



SOSW36N

Sultans Of Swing Wall Lamp

(W.12xH.36xD.12 cm, nickel finish, 1 x E14, 3.5 kg)

Technical details page 313



SOSW50N

Sultans Of Swing Wall Lamp

(W.25xH.50xD.12 cm, nickel finish, 3 x E14, 11 kg)

Technical details page 313

Our Sultans of Swing Elements can be shaped and formed to your needs.

You can select from four different single light objects, each with its own characteristic shaped curls.

You can use them by itself or combine them to fit your needs.



100SOSST

Sultans Of Swing Elements with various curves
(Ø30xH.100 cm, stainless steel, 1 x E14, 2,5 kg)
Technical details page 314



5X100SOSST

Composition of 5xSultans Of Swing Elements with curves C, B, A, B, D
(Ø30xH.100 cm, stainless steel, 1 x E14, 2,5 kg)
Technical details page 314



100SOSST

Sultans Of Swing Elements with various curves
(Ø30xH.100 cm, stainless steel, 1 x E14, 2,5 kg)
Technical details page 314



100SOSST composition

Composition of Sultans Of Swing Elements with various curves
(Ø30xH.100 cm, stainless steel, 1 x E14, 2,5 kg)
Technical details page 314

La Vie en Rose

Design by William Brand

Regardless of our background, we all understand the language of beauty and tenderness.

In every corner of the world, the gift of a bouquet of flowers is answered with a smile.

What more to ask for, what else to give?

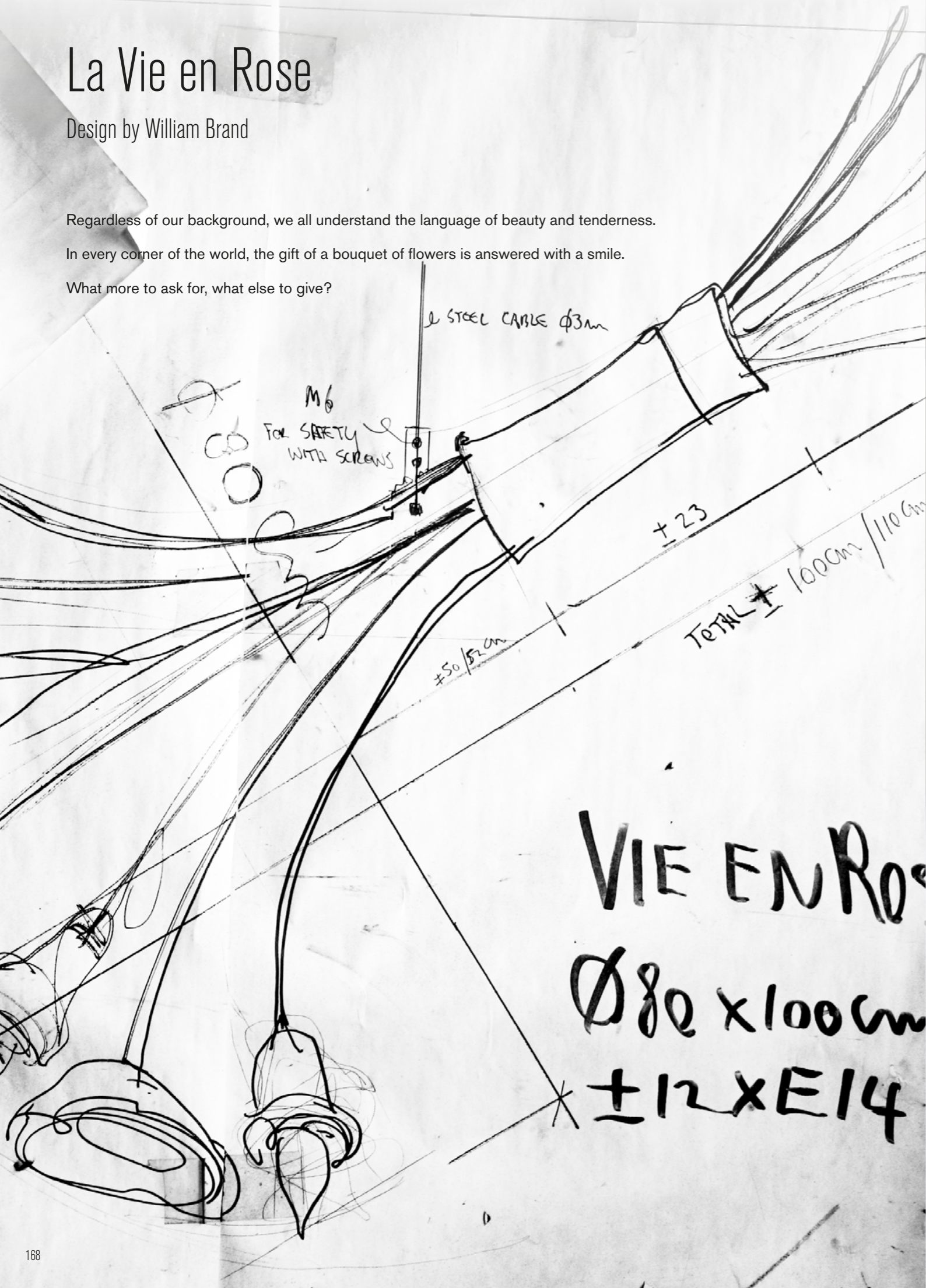

PRIVATE INTERIOR LAREN, NL FEATURING
CUSTOMISED LA VIE EN ROSE COMPOSITION.



COMPOSITION OF LA VIE EN ROSE

Composition of La Vie En Rose Hanging Lamps and Bouquets in various dimensions
(nickel and black finish)

Technical details page 315



COMPOSITION OF LA VIE EN ROSE

Example of 2 different compositions, all combinations possible
 Technical details page 315-316



Composition of LA VIE EN ROSE

Example of a compositions, all combinations possible
 Technical details page 315-316



VERHL120N

La Vie En Rose Hanging Lamp
(L.120xW.40xH.100 cm, nickel finish, 8 x E14, 5 kg)
Technical details page 316



VERW35N

La Vie En Rose Wall Lamp
(L.35xH.65xH.20 cm, nickel finish, 3 x E14, 8 kg)
Technical details page 316

PRIVATE INTERIOR, BUSSUM, NL



LYCC70N

Love You LoveYou Not Chandelier Conical
(Ø.70xH.80 cm, nickel finish, 12 x E14, 28 kg)
Technical details page 317

Love You Love You Not

Design by William Brand

The rose, while the icon of love, also symbolises the thin line between love gained and love lost. It's out of your hands, pick the petals at random, and wonder; she loves me, she loves me not . . .

KONINGSKINDEREN DAY CARE Bussum, NL featuring
Customised LOVE YOU LOVE YOU NOT Chandelier Conical



Customised LYCC

Customised Love You LoveYou Not Chandelier Conical
(Ø.90xH.150cm, white finish, 14 x E14, 32 kg)
Technical details page 317



Customised LYOC80BR

Customised Love You LoveYou Not Chandelier Oval
(L.160xW.70xH.65cm, brass finish, 18 x E14, 41 kg)
Technical details page 317



LYC120N

Love You LoveYou Not Chandelier Round
(Ø.120xH.70 cm, nickel finish, 16 x E14, 55 kg)
Technical details page 318



LYC100BL

Love You LoveYou Not Chandelier Round
(Ø.100xH.55cm, black finish, 14 x E14, 35 kg)
Technical details page 318

W Hotel Doha, QT featuring
Love You Love You Not Chandelier Round
LYC80BL



LYC80BL
Love You Love You Not Chandelier Round
(Ø.80xH.45cm, black finish, 12 x E14, 22 kg)
Technical details page 318

KONINGSKINDEREN DAY CARE Bussum, NL featuring
LOVE YOU LOVE YOU NOT Ceiling lamps



LYP100W
Love You Love You Not Ceiling Lamp
(Ø.100xH.30cm, white finish, 10 x E14, 20 kg)
Technical details page 319

Flower Power

Design by William Brand

Using the latest techniques to cut flowery sensual shapes out of steel plates, Flower Power is a wonderful rendez-vous between handmade and high-tech. All this is combined with especially designed glass drops, that evoke the idea of icicles.



FPHO135BL

Flower Power Chandelier Oval
(L.135xW.65xH.45cm, black finish, 12 x G9, 35 kg)

Technical details page 320



FPHO155W

Flower Power Chandelier Oval
(L.155xW.65xH.45cm, white finish, 12 x G9, 40 kg)
Technical details page 320



FPHO135N

Flower Power Chandelier Oval
(L.135xW.65xH.45cm, nickel finish, 12 x G9, 35 kg)
Technical details page 320

Icy Lady

Design by William Brand

When creating we close our eyes, in order to see. Combining the best materials and techniques to create objects that can be admired both from afar and up close. An elegant and ladylike posture combined with sparkling crystals results in the collection Icy Lady.

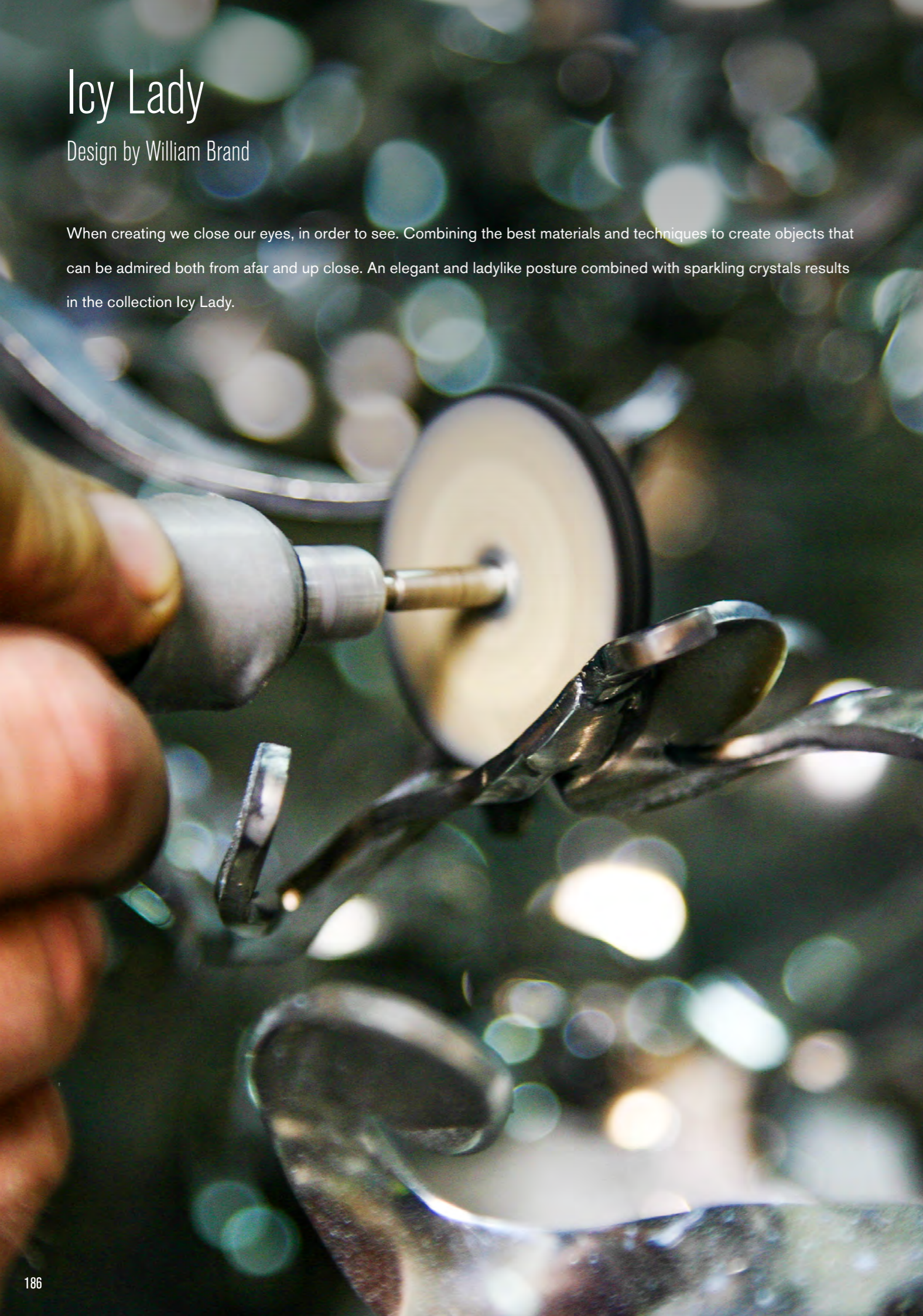

ILC120W

Icy Lady Chandelier Round
(Ø.120xH.55cm, white finish, 12 x G9, 52 kg)

Technical details page 322



ILC100N

Icy Lady Chandelier Round
 (Ø.100xH.45cm, nickel finish, 12 x G9, 34 kg)
 Technical details page 322



ILCUSD120BL

Icy Lady Chandelier Round Upside Down
 (Ø.120xH.55cm, black finish, 12 x G9, 52 kg)
 Technical details page 322



Customised ILC Gold Leaf

Customised Icy Lady Chandelier Round
 (Ø.150xH.150cm, Customised Gold Leaf finish, 12 x G9, 55 kg)





ILP80W

Icy Lady Ceiling Lamp
(Ø.80xH.40cm, white finish, 12 x G9, 26 kg)
Technical details page 323



ILW30N-R

Icy Lady Wall Lamp
(L.30xH.40xD.14cm, nickel finish, 1x E14, 3 kg)
Technical details page 323

Crystal Waters

Design by William Brand

Allowing the fine wiry parts to find their own way, like water leaving a riverbed, a wide range of shapes and dimensions flow smoothly from the collection of Crystal Waters. Eventually, all things merge into one, and a river runs through it...



CWS130NH

Crystal Waters Hanging Lamp Cigar
(L.130xW.50xH.30cm, nickel finish, 16x G9, 8 kg)
Technical details page 324



CWS200NH
Crystal Waters Hanging Lamp Cigar
(L.200xW.55xH.30cm, nickel finish, 26x G9, 15 kg)
Technical details page 324

COSMOPOLITAN HOTEL, VIOLET HOUR LAS VEGAS, US



CWH80NH
Crystal Waters Hanging Lamp "UFO"
(Ø.80xH.30cm, nickel finish, 16x G9, 10 kg)
Technical details page 324

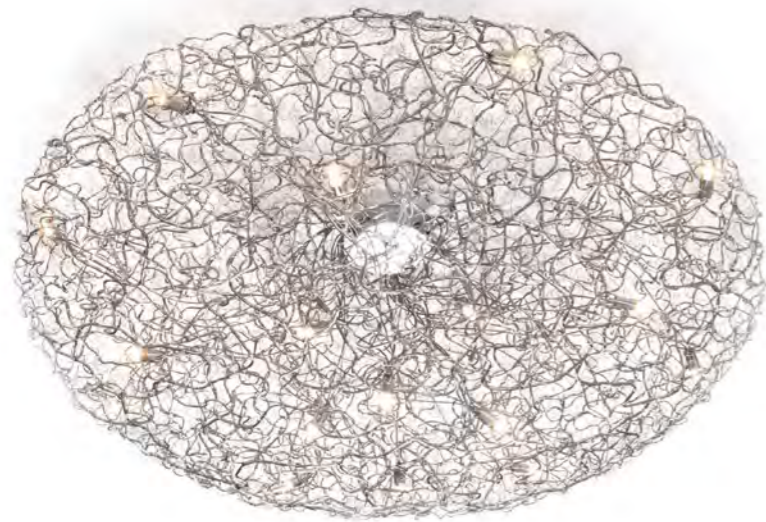

CWP120NH
Crystal Waters Ceiling Lamp
(Ø.120xH.38cm, nickel finish, 19x G9, 16 kg)

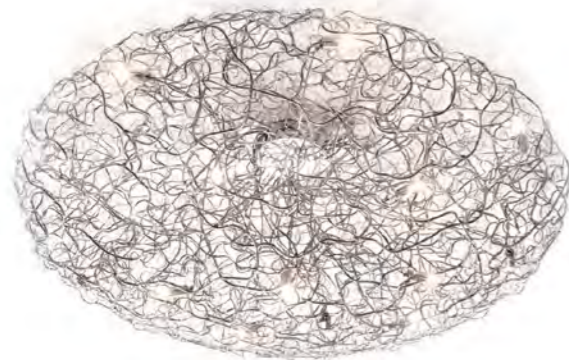

CWP100NH
Crystal Waters Ceiling Lamp
(Ø.100xH.38cm, nickel finish, 16x G9, 12 kg)



CWP80NH
Crystal Waters Ceiling Lamp
(Ø.80xH.38cm, nickel finish, 13x G9, 10 kg)

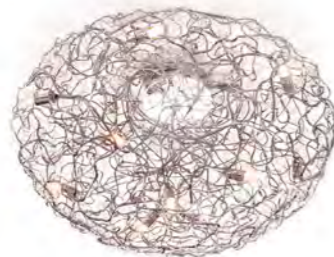

CWP60NH
Crystal Waters Ceiling Lamp
(Ø.60xH.38cm, nickel finish, 10x G9, 5 kg)



CWP40NH
Crystal Waters Ceiling Lamp
(Ø.40xH.28cm, nickel finish, 7x G9, 4 kg)

Technical details page 325

PRIVATE INTERIOR THE HAGUE, NL
A project by Damad Lichtstudio



150CW1N
Crystal Waters Wall Lamp
(W.20xH.27xD.17cm, nickel finish, 1 x E14, 3 kg)
Technical details page 325



CWH130NH

Crystal Waters Drop
(Ø.30xH.130cm, nickel finish, 14 x G9, 9 kg)
Technical details page 325

CWH160NH

Crystal Waters Drop
(Ø.35xH.160cm, nickel finish, 18 x G9, 11 kg)
Technical details page 325

CWH200NH

Crystal Waters Drop
(Ø.40xH.200cm, nickel finish, 24 x G9, 15 kg)
Technical details page 325



3XCWH130NH

Composition of 3xCrystal Waters Drop
(Ø.30xH.130cm, nickel finish, 14 x G9, 9 kg)
Technical details page 325

Delphinium

Design by William Brand

It is a small step from the purity of nature to the pleasures of life, a step taken at the time of the introduction of Delphinium.

The structure of frivolous iron garlands carrying glass elements evokes an almost secret longing for times bygone.

A new stream of dancing designs comes to the fore, all with a playful hint of hedonism.



DCC70N

Delphinium Chandelier Conical
(Ø.70xH.80cm, nickel finish, 10 x E14, 25 kg)
Technical details page 326



DOC70N

Delphinium Chandelier Oval
(L.140xW.70xH.55cm, nickel finish, 12 x E14, 29 kg)
Technical details page 326

PRIVATE INTERIOR KITZBÜHEL
INTERIOR DESIGN BY SPLENDID ARCHITECTURE GBR



DC140N

Delphinium Chandelier Round
(Ø.140xH.70cm, nickel finish, 20 x E14, 67 kg)
Technical details page 326



Paul Noyen

2XDC100N

Delphinium Chandelier Round
(Ø.100xH.55cm, nickel finish, 12 x E14, 27 kg)
Technical details page 326



DC120N

Delphinium Chandelier Round
(Ø.120xH.70cm, nickel finish, 16 x E14, 35 kg)
Technical details page 326



DP80N
Delphinium Ceiling Lamp Round
(Ø.80xH.35cm, nickel finish, 6x E14, 17 kg)
Technical details page 327



DW35N
Delphinium Wall Lamp
(W.40xH.75xD.20cm, nickel finish, 3x E14, 7 kg)
Technical details page 327

Hollywood

Design by William Brand

Travelling through Africa with his family, William was touched by the slenderness and pure beauty of the branches and trees scattered across the land. Just as nature comes in all forms and shapes the Hollywood line is equally diverse, including round, conical and square shapes.



HCC90N

Hollywood Chandelier Conical.

Any size as customised object possible

(Ø.90xH.130cm, nickel finish, 16x E14, 27 kg)

Technical details page 328



HCC90N

Hollywood Chandelier Conical.

Any size as customised object possible

(Ø.90xH.130cm, nickel finish, 16x E14, 27 kg)

Technical details page 328



HCC60N

Hollywood Chandelier Conical.

Any size as customised object possible

(Ø.60xH.100cm, nickel finish, 16x E14, 27 kg)

Technical details page 328



HCC90W
Hollywood Chandelier Conical.
Any size as customised object possible
(Ø90xH.130cm, white finish, 16x E14, 27 kg)
Technical details page 328



HCC140N
Hollywood Chandelier Conical Oval.
Any size as customised object possible
(L.140xW.55xH.85cm, nickel finish, 14x E14, 26 kg)
Technical details page 328



HC120N
Hollywood Chandelier Round.
Any size as customised object possible
(Ø.120xH.25cm, nickel finish, 10x E14, 28 kg)
Technical details page 329



HCCH10x10N
Hollywood Chandelier Candlestick Round.
Any size as customised object possible
(Ø.100xH.40cm, nickel finish, 12x E14, 25 kg)
Technical details page 330



HW45N

Hollywood Wall Lamp Block.

Any size as customised object possible

(W.20xH.45xD.25cm, nickel finish, 1x E27, 6 kg)

Technical details page 334

HC120N

Hollywood Chandelier Round.

Any size as customised object possible

(Ø.120xH.25cm, nickel finish, 10x E14, 28 kg)

Technical details page 329

HF190N

Hollywood Floor Lamp Block.

Any size as customised object possible

(L.40xW.40xH.190cm, nickel finish, 1x E27, 23 kg)

Technical details page 333



HPH80N

Hollywood Ceiling Chandelier.

Any size as customised object possible

(Ø.80xH.80cm, nickel finish, 12x E14, 11 kg)

Technical details page 332



HH25N-4IL

Hollywood Hanging Lamp In line.

(L.145xW.25xH.30cm, nickel finish, 4x E27, 37 kg)

Technical details page 330



CUSTOMISED HHL225N

Customised Hollywood Hanging Lamp Long.

Any size as customised object possible

(L.225xW.25xH.30cm, nickel finish, 7x E27, 30 kg)



2x Customised HCC50N

Hollywood Hanging Lamp Block.

Any size as customised object possible

(L.50xW.50xH.50cm, nickel finish, 1x E27, 13 kg)



CUSTOMISED HP60COP/ HP60BRA/ HP60BR

Hollywood Ceiling Lamp Round in various customised finishes
(Ø.60xH.25cm, copper/ brass aged/ brass finish, 6x E14, 6kg)
Technical details page 332



HW30N-L

Hollywood Wall Lamp, left version
(W.20xH.45xD.15cm, nickel finish, 1x E14, 1kg)
Technical details page 334



HW45N

Hollywood Wall Lamp Block
(W.20xH.45xD.25cm, nickel finish, 1x E27, 6kg)
Technical details page 334



HF170W

Hollywood Floor Lamp Block
(L.30xW.30xH.170cm, white finish, 1x E27, 18kg)
Technical details page 333



HF190N

Hollywood Floor Lamp
(L.40xW.40xH.190cm, nickel finish 1x E27, 23kg)
Technical details page 333



HF170N

Hollywood Floor Lamp Block
(L.30xW.30xH.170cm, nickel finish, 1x E27, 18kg)
Technical details page 333



HT55N

Hollywood Table Lamp Block
(L.20xW.20xH.55cm, nickel finish, 1x E27, 6,5kg)
Technical details page 333

HW45N

Hollywood Wall Lamp Block
(W.20xH.45xD.25cm, nickel finish 1x E27, 6kg)
Technical details page 334

HF170N

Hollywood Floor Lamp Block
(L.30xW.30xH.170cm, nickel finish, 1x E27, 18kg)
Technical details page 333



HT70N

Hollywood Table Lamp Block
(L.30xW.30xH.70cm, nickel finish, 1x E27, 14kg)
Technical details page 333

Hollywood Glass

Design by William Brand

The Hollywood collection doesn't just come in all forms and shapes, but can also be combined with glass icicles. Adding them brings extra character and strength at the very same time.

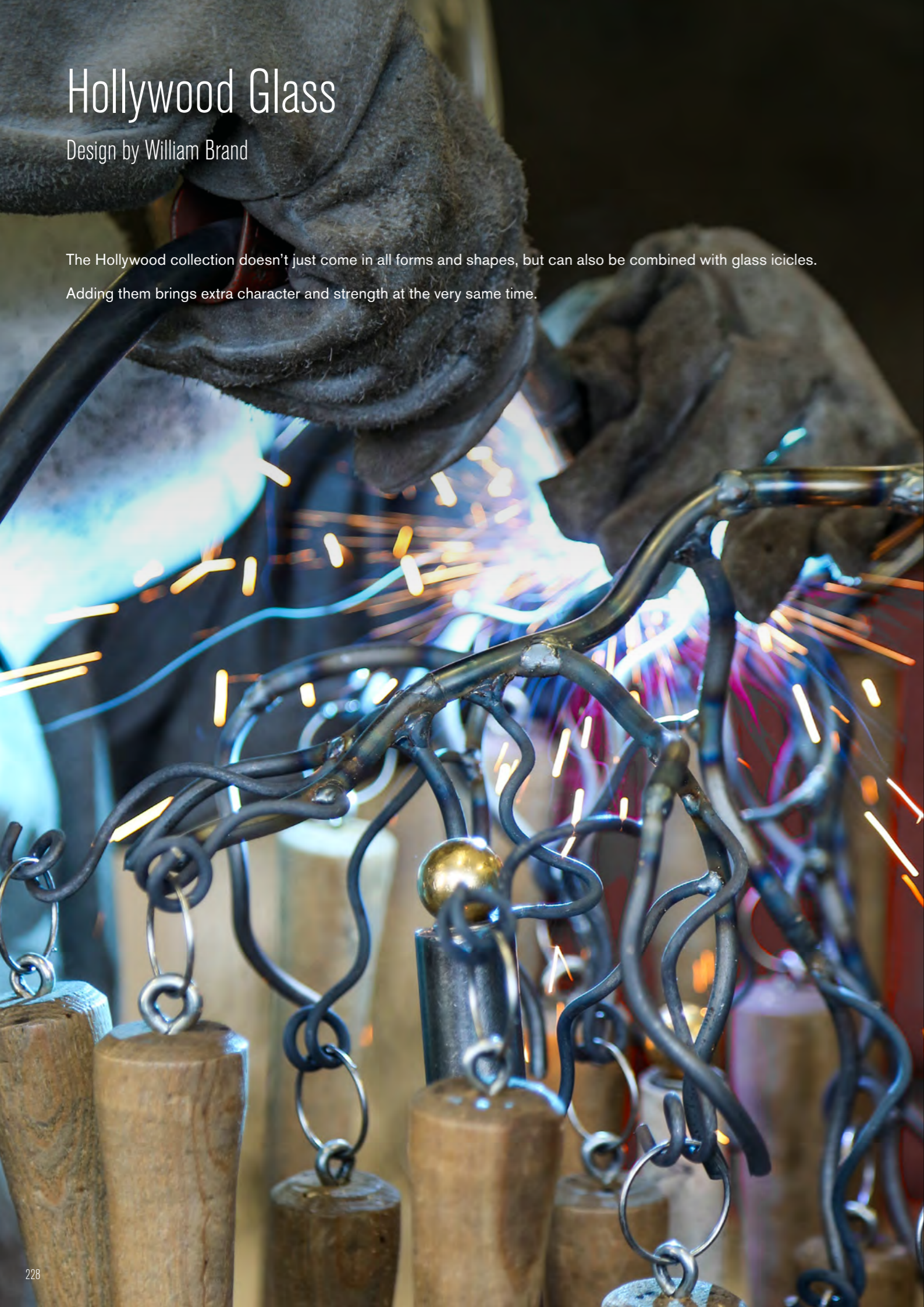

HCCGL100N

Hollywood Chandelier Conical Glass.

Any size as customised object possible

(Ø.100xH.125cm, nickel finish, 16x E14, 44 kg)

Technical details page 335



HCCGL100N
Hollywood Chandelier Conical Glass.
Any size as customised object possible
(Ø.100xH.125cm, nickel finish, 16x E14, 44 kg)
Technical details page 335



HCCGL80N

Hollywood Chandelier Conical Glass.

Any size as customised object possible

(Ø.80xH.100cm, nickel finish, 12x E14, 33 kg)

Technical details page 335



HCCGL80BL

Hollywood Chandelier Conical Glass.

Any size as customised object possible

(Ø.80xH.100cm, black finish 12x E14, 33 kg)

Technical details page 335



CUSTOMISED HCCGL80B

Customised Hollywood Chandelier Conical Glass.

Any size as customised object possible

(Ø.80xH.180cm, bronze finish, 16x E14, 45 kg)



HOCGL140N

Hollywood Chandelier Oval Glass.

Any size as customised object possible

(L.140xW.55xH.85cm, nickel finish, 14x E14, 37 kg)

Technical details page 335





CUSTOMISED HOLLYWOOD GLASS

Customised Hollywood Chandelier Conical Glass. Hollow Icicles of 30, 40 and 50cm length

Any size as customised object possible

(Ø.140xH.160cm, nickel finish, 16x E14, 65 kg)



Customised Hollywood Glass

Customised Hollywood Chandelier Conical Glass. Hollow Icicles of 40, 50 and 70cm length.

Any size as customised object possible

(Ø.100xH.180cm, nickel finish, 16x E14, 50kg)



HPGL120N

Hollywood Ceiling Chandelier Glass

Any size as customised object possible

(Ø.120xH.65cm, nickel finish, 15x E14, 60kg)

Technical details page 336



HPGL60N

Hollywood Ceiling Chandelier Glass

Any size as customised object possible

(Ø.60xH.50cm, nickel finish, 8x E14, 22kg)

Technical details page 336



HPGLH80N

Hollywood Ceiling Chandelier Glass High

Any size as customised object possible

(Ø.80xH.80cm, nickel finish, 12x E14, 34kg)

Technical details page 336

Eve Icicles

Design by William Brand

Combining the Eve with the time honoured tradition of hand-blown glass: the Eve Icicles has been created.

Eve Icicles can be customised to any dimension, allowing for a tailor-made lighting sculpture for your space.



CUSTOMISED EVECCGL160N

Eve Chandelier Conical Glass

(Ø60xH.160 cm, nickel finish, 14 x E14, 36 kg)



CUSTOMISED EVECCGL160N

Eve Chandelier Conical Glass

(Ø60xH.160 cm, nickel finish, 14 x E14, 36 kg)

EVEOC140N

Eve Chandelier Oval

(L.140xW.60xH.60 cm, nickel finish, 12 x E14, 16 kg)

Technical details page 293



CUSTOMISED EVECCGL300N

Customised Eve Chandelier Conical Glass
(Ø150xH.300 cm, nickel finish, 52 x E14, 100 kg)



CUSTOMISED EVECCGL300N

Customised Eve Chandelier Conical Glass
(Ø150xH.300 cm, nickel finish, 52 x E14, 100 kg)



CUSTOMISED EVEOCGL140RUST

Customised Eve Chandelier Oval Glass

(L. 140cmxW. 60cmxH. 60cm, rusty finish 16xE14, 25kg.)



CUSTOMISED EVEOCGL140RUST

Customised Eve Chandelier Oval Glass

(L. 140cmxW. 60cmxH. 60cm, rusty finish 16xE14, 25kg.)



CUSTOMISED EVEOCGL140RUST

Customised Eve Chandelier Oval Glass

(L. 140cmxW. 60cmxH. 60cm, rusty finish 16xE14, 25kg.)

Flower Power Icicles

Design by William Brand

Our exquisite 'Flower Power' found herself refreshed with a breath of fresh air and stylish icicles.



Customised Flower Power

Customised Flower Power Icicles Chandelier Oval
(Ø 140, H 70 cm, 10xG9, 35kg, nickel aged finish)

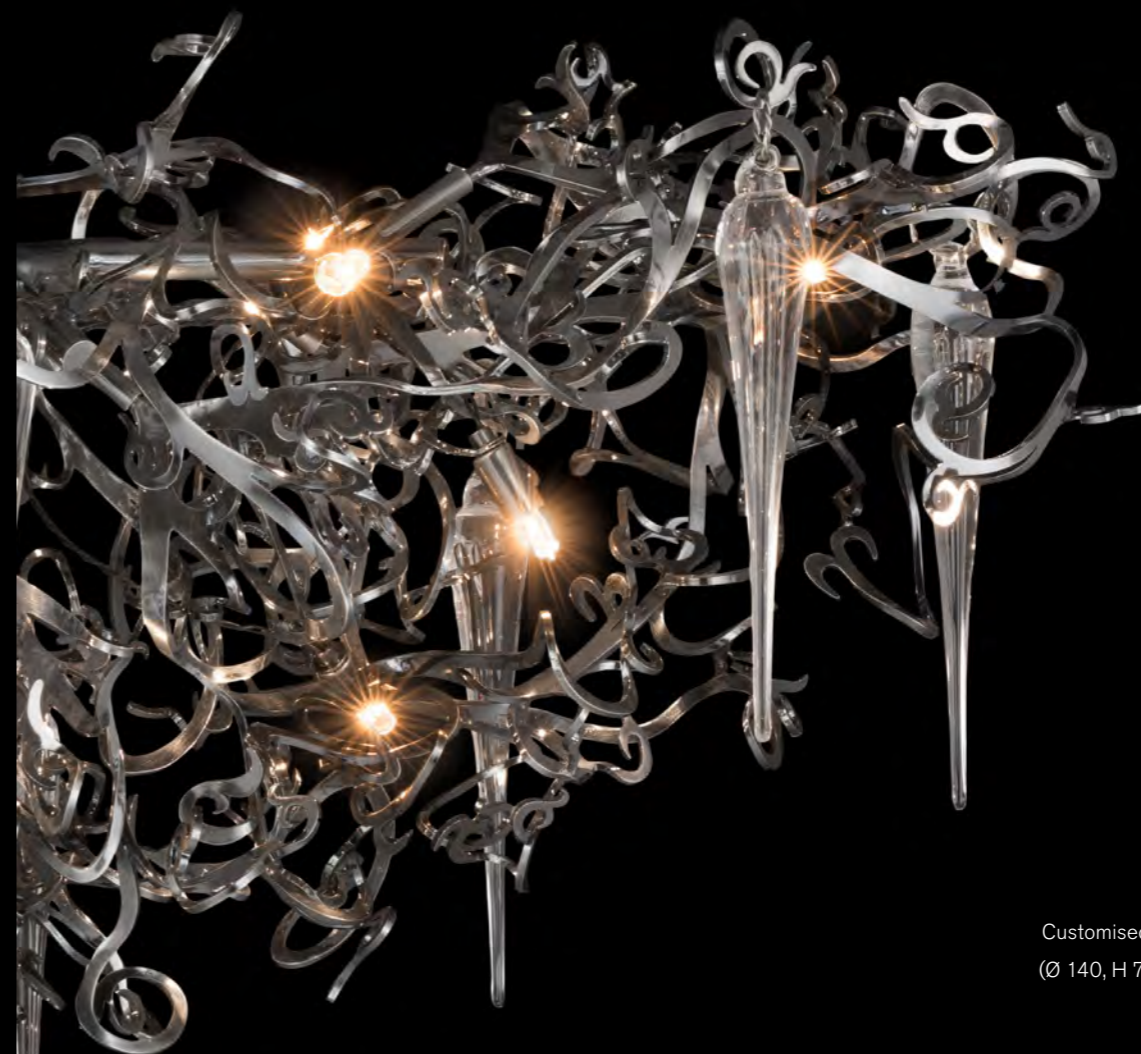

Customised Flower Power

Customised Flower Power Icicles Chandelier Oval
(Ø 140, H 70 cm, 10xG9, 35kg, nickel aged finish)



CUSTOMISED FPI100BL

Customised Flower Power Icicles Chandelier Round
(Ø 100, H 70 cm, 8xE27, 25kg, black finish)



CUSTOMISED FPI100BL

Customised Flower Power Icicles Chandelier Round
(Ø 100, H 70 cm, 8xE27, 25kg, black finish)



Customised Flower Power Icicles

Customised Flower Power Icicles Chandelier for Residential Villa
(Ø180xH.400 cm, black finish with black glass icicles)

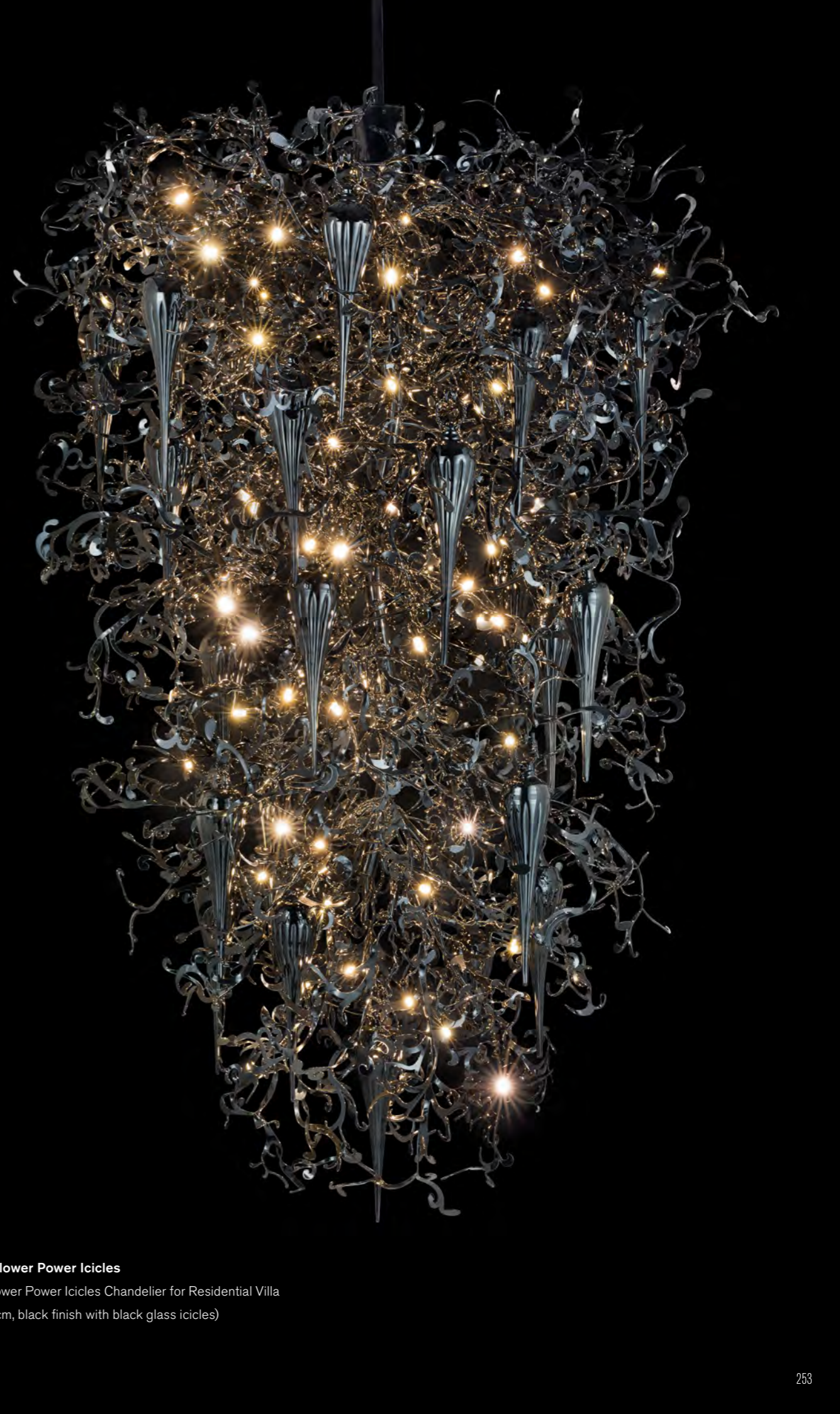

Customised Flower Power Icicles

Customised Flower Power Icicles Chandelier for Residential Villa
(Ø180xH.400 cm, black finish with black glass icicles)

Evergreens

Design by William Brand

Collections that are no longer in regular production, shown here, can at times still be produced on request.



BROOM HANGING LAMP



RHAPSODY IN BLUE CUSTOMISED HANGING LAMP



FLOATING CANDLES CUSTOMISED COMPOSITION



CANDLES AND SPIRITS CHANDELIER



COCO CUSTOMISED CHANDELIER



EDISON'S TAIL CUSTOMISED COMPOSITION

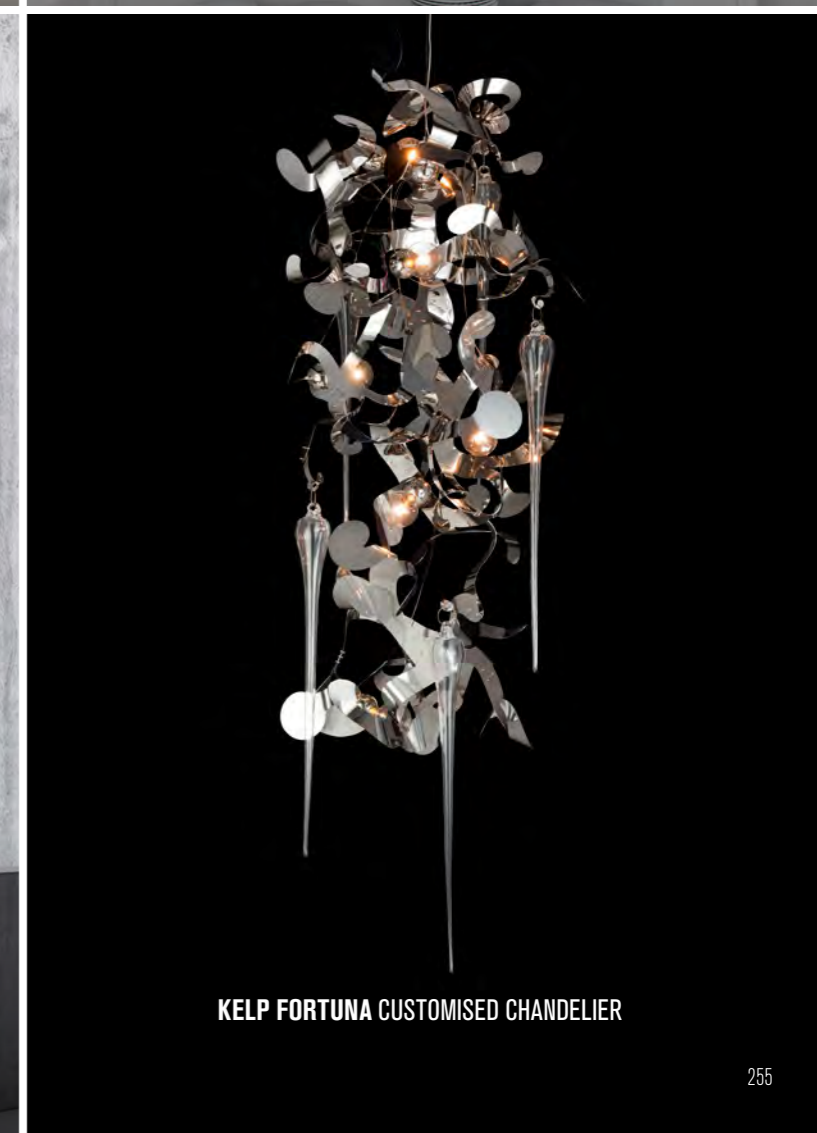

KELP FORTUNA CUSTOMISED CHANDELIER

Evergreens

Design by William Brand

Collections that are no longer in regular production, shown here, can at times still be produced on request.



LOLA CHANDELIER



NIGHT WATCH CUSTOMISED CHANDELIER



TABLE D' AMIS CHANDELIER



DIAMONDS FROM AMSTERDAM HANGING LAMP



Architects and other co-creatives are invited to discover the endless possibilities of customising our lighting sculptures.

We hope to inspire you through the different colours and forms of various compositions, just as we enjoy being stimulated by your requests. William Brand's background in architecture gives him the insight to fully understand the demands and challenges of your work. Combined with his experience he is the perfect partner to translate your needs into handcrafted reality.

For our clients we not only customise to different dimensions, but also in different finishes: allowing for a truly personal lighting sculpture to be created.

The possibilities with our lighting sculptures are, in fact, limitless.

We would like to show some of the new possibilities.



Optional finishes

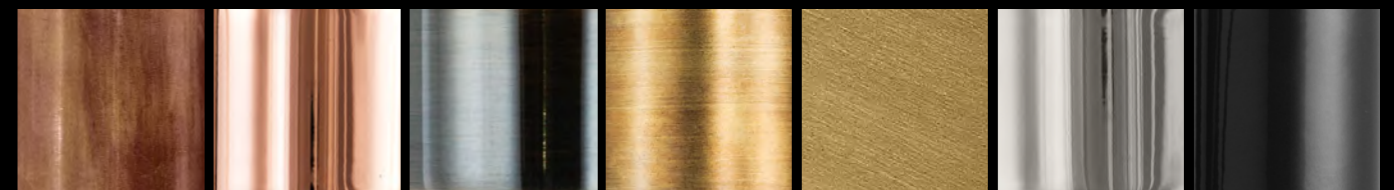

020	013	018	012	017	011	003
Copper burnished* finish	Copper finish	Nickel aged finish*	Brass aged finish*	Brass grinded finish	Stainless Steel (high gloss)	Black finish (high gloss)



010	002	004	001	019	008	005
Brass finish	Black matt finish	White matt finish	Nickel finish	Brass burnished* finish	Bronze finish (powder coated)	White finish (high gloss)

* Due to the unique process of creating the finishes Brass Burnished, Brass Aged, Nickel Aged and Copper Burnished, lights that will be combined in the same space should be ordered at the same time, in order to prevent lights from looking slightly different from each other. These finishes are created through a natural process and can result in random oxidized patterns.

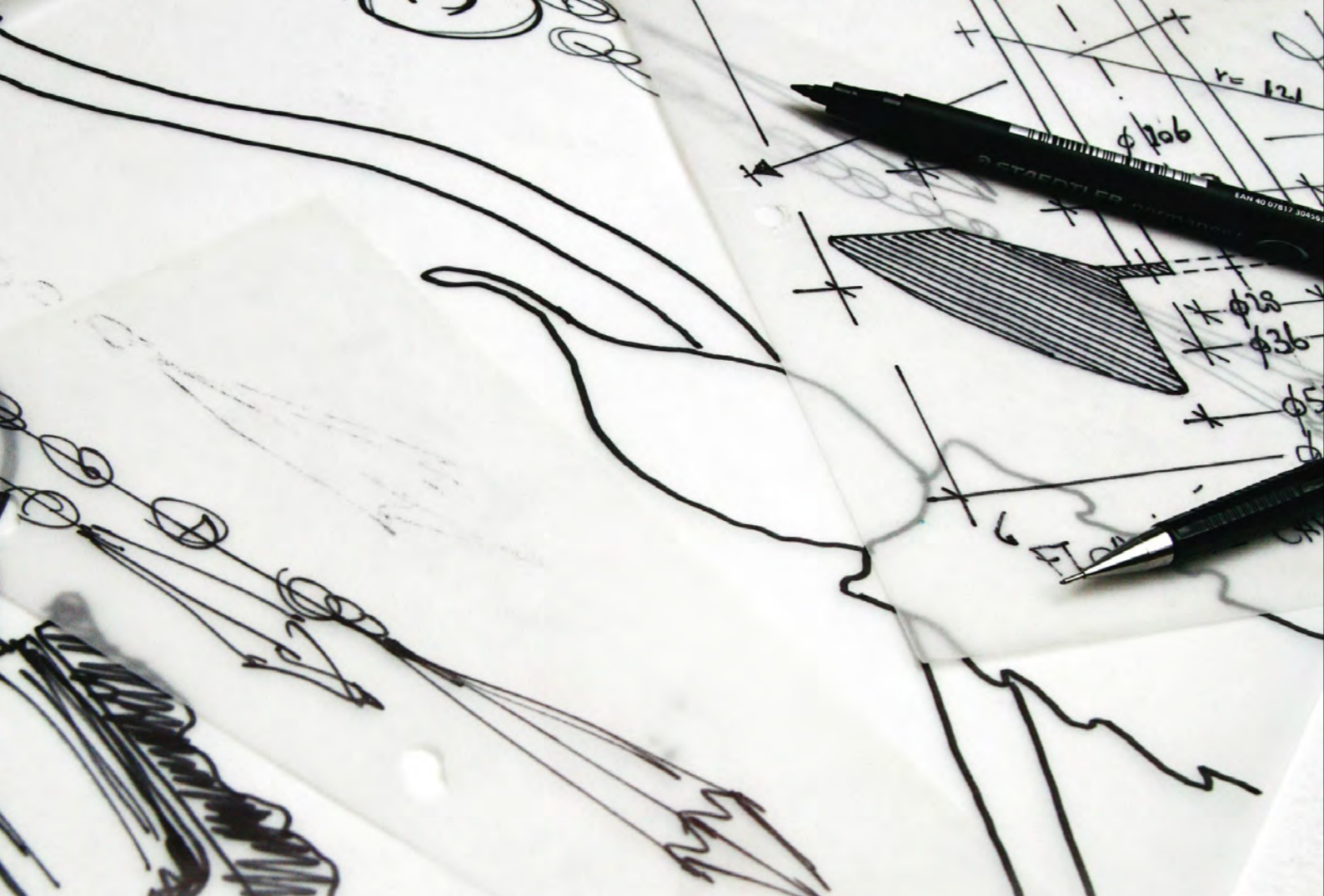

William Brand

Founder / Designer

William Brand (Owner/Designer) graduated at the University of the Arts in Utrecht, The Netherlands as an architect and sculptor.

As an award-winning furniture designer he for many years designed buildings and interiors for fashion brands, including the headquarters of BRAND VAN EGMOND. His interior designs are always minimalist, in contrast to his lighting designs which have a powerful sculptural presence. He considers his lighting objects to be "the cherry on the cake". His way of working is quite specific. Immediately after defining the concept he starts working in the workshop like a sculptor; experimenting and crafting while having the object grow in his hands, often with unexpected results. Therefore the journey is just as exciting and important as the destination.



Certificate



Each BRAND VAN EGMOND lighting sculpture is issued with a certificate of authenticity and registered with a unique number. This guarantees that you are in possession of an original BRAND VAN EGMOND object.

We advise you to keep this certificate together with your receipt of purchase in a safe place.

Technical information



Technical information

Collection Linea 2019

Chandelier Round

Art.nr.	Dimensions	Light bulb	Weight	Finish
LINC60BLM	Ø60xH.50 cm	3x S14D	15,0 kg	black matt finish
LINC60N	Ø60xH.50 cm	3x S14D	15,0 kg	nickel finish
LINC60BR	Ø60xH.50 cm	3x S14D	15,0 kg	brass finish
LINC60BRBUR	Ø60xH.50 cm	3x S14D	15,0 kg	brass burnished finish
LINC60NA	Ø60xH.50 cm	3x S14D	15,0 kg	nickel aged finish
LINC80BLM	Ø80xH.60 cm	6x S14D	20,0 kg	black matt finish
LINC80N	Ø80xH.60 cm	6x S14D	20,0 kg	nickel finish
LINC80BR	Ø80xH.60 cm	6x S14D	20,0 kg	brass finish
LINC80BRBUR	Ø80xH.60 cm	6x S14D	20,0 kg	brass burnished finish
LINC80NA	Ø80xH.60 cm	6x S14D	20,0 kg	nickel aged finish
LINC100BLM	Ø100xH.70 cm	7x S14D	25,0 kg	black matt finish
LINC100N	Ø100xH.70 cm	7x S14D	25,0 kg	nickel finish
LINC100BR	Ø100xH.70 cm	7x S14D	25,0 kg	brass finish
LINC100BRBUR	Ø100xH.70 cm	7x S14D	25,0 kg	brass burnished finish
LINC100NA	Ø100xH.70 cm	7x S14D	25,0 kg	nickel aged finish
LINC120BLM	Ø120xH.80 cm	8x S14D	30,0 kg	black matt finish
LINC120N	Ø120xH.80 cm	8x S14D	30,0 kg	nickel finish
LINC120BR	Ø120xH.80 cm	8x S14D	30,0 kg	brass finish
LINC120BRBUR	Ø120xH.80 cm	8x S14D	30,0 kg	brass burnished finish
LINC120NA	Ø120xH.80 cm	8x S14D	30,0 kg	nickel aged finish

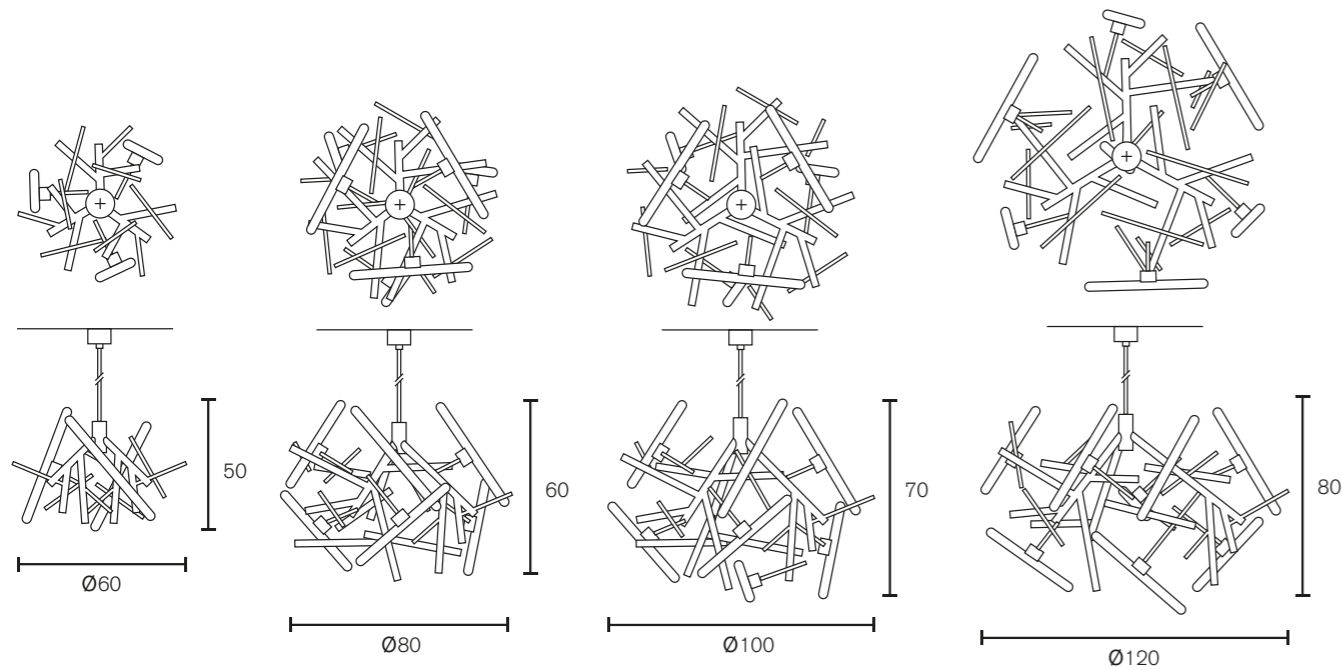

Standard the Linea will be delivered with reflector bars in the finish of the lamp. The reflector bars can be delivered in various finishes on request. All Chandeliers are supplied with 2 meter stem and a ceiling shade.

Technical information

Element

Art.nr.	Dimensions	Light bulb	Weight	Finish
LINLT50/70BLM	Ø70xH.70 cm	5x S14D	6,0 kg	black matt finish
LINLT50/70N	Ø70xH.70 cm	5x S14D	6,0 kg	nickel finish
LINLT50/70BR	Ø70xH.70 cm	5x S14D	6,0 kg	brass finish
LINLT50/70BRBUR	Ø70xH.70 cm	5x S14D	6,0 kg	brass burnished finish
LINLT50/70NA	Ø70xH.70 cm	5x S14D	6,0 kg	nickel aged finish

Element with downlight

Art.nr.	Dimensions	Light bulb	Weight	Finish
LINLTDL50/70BLM	Ø70xH.70 cm	5x S14D	8,0 kg	1x GU10 spot downlight, black matt finish
LINLTDL50/70N	Ø70xH.70 cm	5x S14D	8,0 kg	1x GU10 spot downlight, nickel finish
LINLTDL50/70BR	Ø70xH.70 cm	5x S14D	8,0 kg	1x GU10 spot downlight, brass finish
LINLTDL50/70BRBUR	Ø70xH.70 cm	5x S14D	8,0 kg	1x GU10 spot downlight, brass burnished finish
LINLTDL50/70NA	Ø70xH.70 cm	5x S14D	8,0 kg	1x GU10 spot downlight, nickel aged finish



Wall lamp

Art.nr.	Dimensions	Light bulb	Weight	Finish
LINW60BLM	L.12xW.12xH.60 cm	1x S14D	4,0 kg	black matt finish
LINW60N	L.12xW.12xH.60 cm	1x S14D	4,0 kg	nickel finish
LINW60BR	L.12xW.12xH.60 cm	1x S14D	4,0 kg	brass finish
LINW60BRBUR	L.12xW.12xH.60 cm	1x S14D	4,0 kg	brass burnished finish
LINW60NA	L.12xW.12xH.60 cm	1x S14D	4,0 kg	nickel aged finish

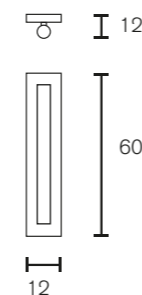

Standard the Linea will be delivered with reflector bars in finish of the lamp. The reflector bars can be delivered in various finishes on request. All elements are supplied with 3 meter steel cable, 3 meter electrical cable and a ceiling shade.

Technical information

Hanging Lamp Long

Art.nr.	Dimensions	Light bulb	Weight	Finish
LINHL120BLM	L.120xW.60xH.50 cm	6x S14D	30,0 kg	3x GU10 spot downlight, black matt finish
LINHL120N	L.120xW.60xH.50 cm	6x S14D	30,0 kg	3x GU10 spot downlight, nickel finish
LINHL120BR	L.120xW.60xH.50 cm	6x S14D	30,0 kg	3x GU10 spot downlight, brass finish
LINHL120BRBUR	L.120xW.60xH.50 cm	6x S14D	30,0 kg	3x GU10 spot downlight, brass burnished finish
LINHL120NA	L.120xW.60xH.50 cm	6x S14D	30,0 kg	3x GU10 spot downlight, nickel aged finish
LINHL140BLM	L.140xW.60xH.50 cm	6x S14D	40,0 kg	3x GU10 spot downlight, black matt finish
LINHL140N	L.140xW.60xH.50 cm	6x S14D	40,0 kg	3x GU10 spot downlight, nickel finish
LINHL140BR	L.140xW.60xH.50 cm	6x S14D	40,0 kg	3x GU10 spot downlight, brass finish
LINHL140BRBUR	L.140xW.60xH.50 cm	6x S14D	40,0 kg	3x GU10 spot downlight, brass burnished finish
LINHL140NA	L.140xW.60xH.50 cm	6x S14D	40,0 kg	3x GU10 spot downlight, nickel aged finish
LINHL160BLM	L.160xW.60xH.50 cm	8x S14D	45,0 kg	4x GU10 spot downlight, black matt finish
LINHL160N	L.160xW.60xH.50 cm	8x S14D	45,0 kg	4x GU10 spot downlight, nickel finish
LINHL160BR	L.160xW.60xH.50 cm	8x S14D	45,0 kg	4x GU10 spot downlight, brass finish
LINHL160BRBUR	L.160xW.60xH.50 cm	8x S14D	45,0 kg	4x GU10 spot downlight, brass burnished finish
LINHL160NA	L.160xW.60xH.50 cm	8x S14D	45,0 kg	4x GU10 spot downlight, nickel aged finish
LINHL180BLM	L.180xW.60xH.50 cm	8x S14D	50,0 kg	4x GU10 spot downlight, black matt finish
LINHL180N	L.180xW.60xH.50 cm	8x S14D	50,0 kg	4x GU10 spot downlight, nickel finish
LINHL180BR	L.180xW.60xH.50 cm	8x S14D	50,0 kg	4x GU10 spot downlight, brass finish
LINHL180BRBUR	L.180xW.60xH.50 cm	8x S14D	50,0 kg	4x GU10 spot downlight, brass burnished finish
LINHL180NA	L.180xW.60xH.50 cm	8x S14D	50,0 kg	4x GU10 spot downlight, nickel aged finish

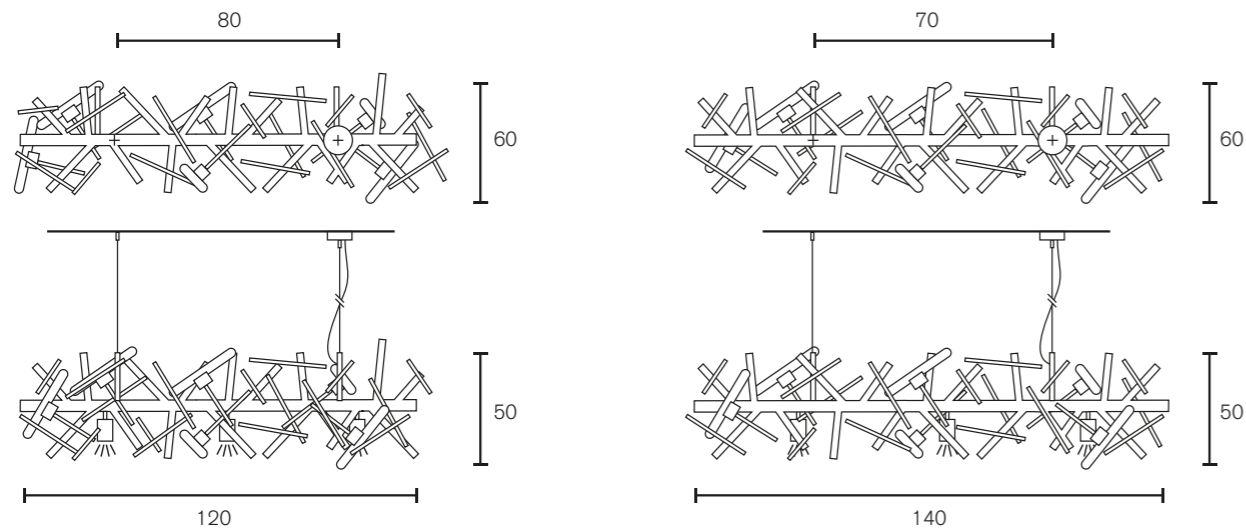

Standard the Linea will be delivered with reflector bars in finish of the lamp. The reflector bars can be delivered in various finishes on request
All Hanging Lamps Long are supplied with 3 meter steel cable, 3 meter electrical cable and a ceiling shade.

Technical information

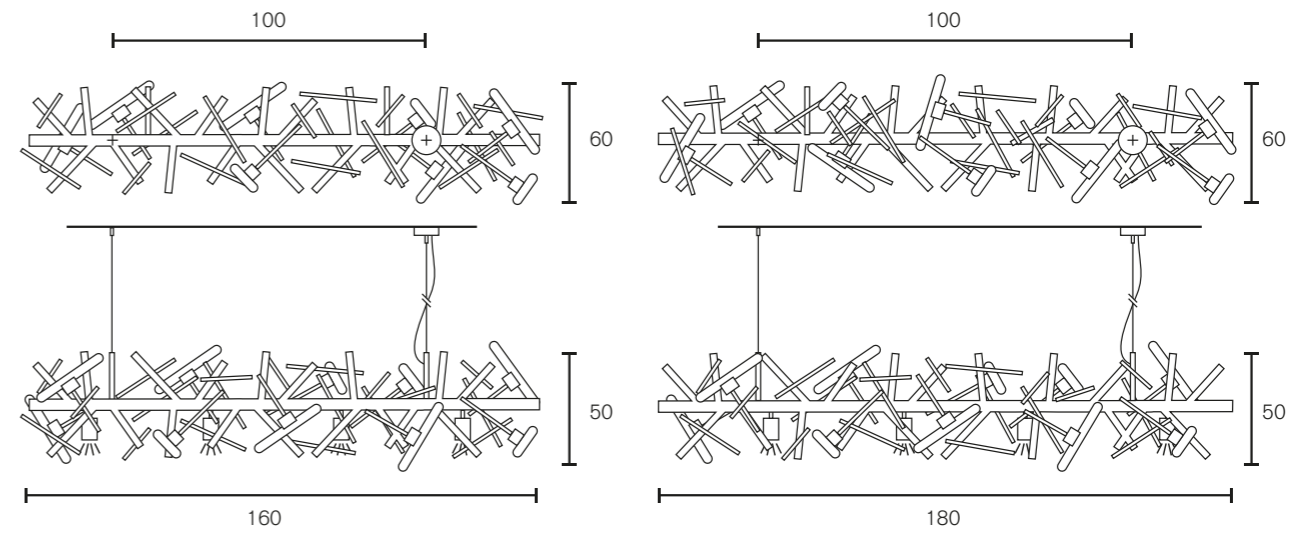

Ceiling Lamp Round

Art.nr.	Dimensions	Light bulb	Weight	Finish
LINP60BLM	Ø60xW.45 cm	3x S14D	15,0 kg	black matt finish
LINP60N	Ø60xW.45 cm	3x S14D	15,0 kg	nickel finish
LINP60BR	Ø60xW.45 cm	3x S14D	15,0 kg	brass finish
LINP60BRBUR	Ø60xW.45 cm	3x S14D	15,0 kg	brass burnished finish
LINP60NA	Ø60xW.45 cm	3x S14D	15,0 kg	nickel aged finish
LINP80BLM	Ø80xW.50 cm	6x S14D	20,0 kg	black matt finish
LINP80N	Ø80xW.50 cm	6x S14D	20,0 kg	nickel finish
LINP80BR	Ø80xW.50 cm	6x S14D	20,0 kg	brass finish
LINP80BRBUR	Ø80xW.50 cm	6x S14D	20,0 kg	brass burnished finish
LINP80NA	Ø80xW.50 cm	6x S14D	20,0 kg	nickel aged finish
LINP100BLM	Ø100xW.50 cm	6x S14D	25,0 kg	black matt finish
LINP100N	Ø100xW.50 cm	6x S14D	25,0 kg	nickel finish
LINP100BR	Ø100xW.50 cm	6x S14D	25,0 kg	brass finish
LINP100BRBUR	Ø100xW.50 cm	6x S14D	25,0 kg	brass burnished finish
LINP100NA	Ø100xW.50 cm	6x S14D	25,0 kg	nickel aged finish

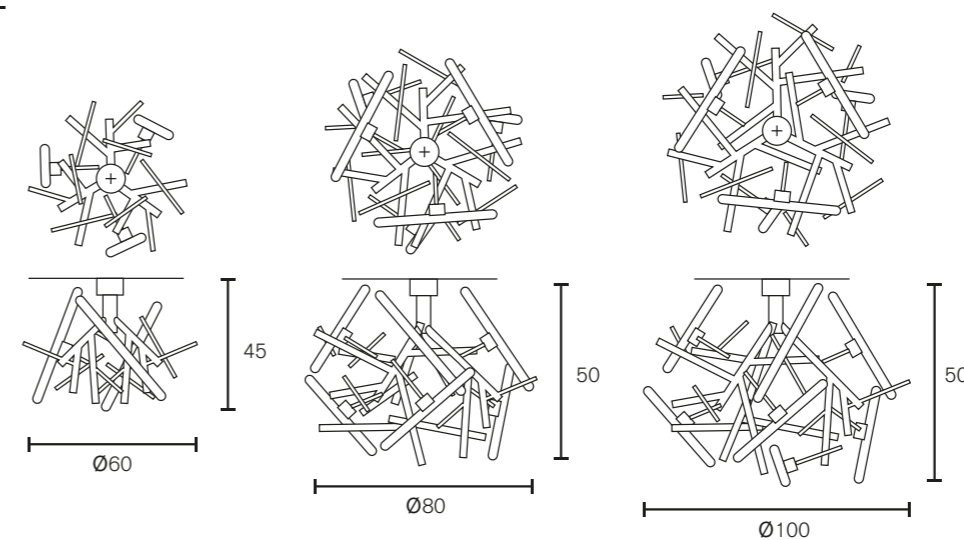

Standard the Linea will be delivered with reflector bars in finish of the lamp. The reflector bars can be delivered in various finishes on request
All Hanging Lamps Long are supplied with 3 meter steel cable, 3 meter electrical cable and a ceiling shade.

Technical information

Collection Galaxy 2019

Chandelier Round

Art.nr.	Dimensions	Light bulb	Weight	Finish
GALC80BLM	Ø80xH.70 cm	3x E27	12.0 kg	black matt finish
GALC80N	Ø80xH.70 cm	3x E27	12.0 kg	nickel finish
GALC80BR	Ø80xH.70 cm	3x E27	12.0 kg	brass finish
GALC80BRBUR	Ø80xH.70 cm	3x E27	12.0 kg	brass burnished finish
GALC80NA	Ø80xH.70 cm	3x E27	12.0 kg	nickel aged finish
GALC100BLM	Ø90xH.110 cm	5x E27	17,0 kg	black matt finish
GALC100N	Ø90xH.110 cm	5x E27	17.0 kg	nickel finish
GALC100BR	Ø90xH.110 cm	5x E27	17,0 kg	brass finish
GALC100BRBUR	Ø90xH.110 cm	5x E27	17.0 kg	brass burnished finish
GALC100NA	Ø90xH.110 cm	5x E27	17.0 kg	nickel aged finish

Chandelier Round with downlight

Art.nr.	Dimensions	Light bulb	Weight	Finish
GALCDL80BLM	Ø80xH.70 cm	3x E27	14,0 kg	1x GU10 spot downlight, black matt finish
GALCDL80N	Ø80xH.70 cm	3x E27	14,0 kg	1x GU10 spot downlight, nickel finish
GALCDL80BR	Ø80xH.70 cm	3x E27	14,0 kg	1x GU10 spot downlight, brass finish
GALCDL80BRBUR	Ø80xH.70 cm	3x E27	14,0 kg	1x GU10 spot downlight, brass burnished finish
GALCDL80NA	Ø80xH.70 cm	3x E27	14,0 kg	1x GU10 spot downlight, nickel aged finish
GALCDL100BLM	Ø90xH.110 cm	5x E27	19,0 kg	1x GU10 spot downlight, black matt finish
GALCDL100N	Ø90xH.110 cm	5x E27	19,0 kg	1x GU10 spot downlight, nickel finish
GALCDL100BR	Ø90xH.110 cm	5x E27	19,0 kg	1x GU10 spot downlight, brass finish
GALCDL100BRBUR	Ø90xH.110 cm	5x E27	19,0 kg	1x GU10 spot downlight, brass burnished finish
GALCDL100NA	Ø90xH.110 cm	5x E27	19,0 kg	1x GU10 spot downlight, nickel aged finish

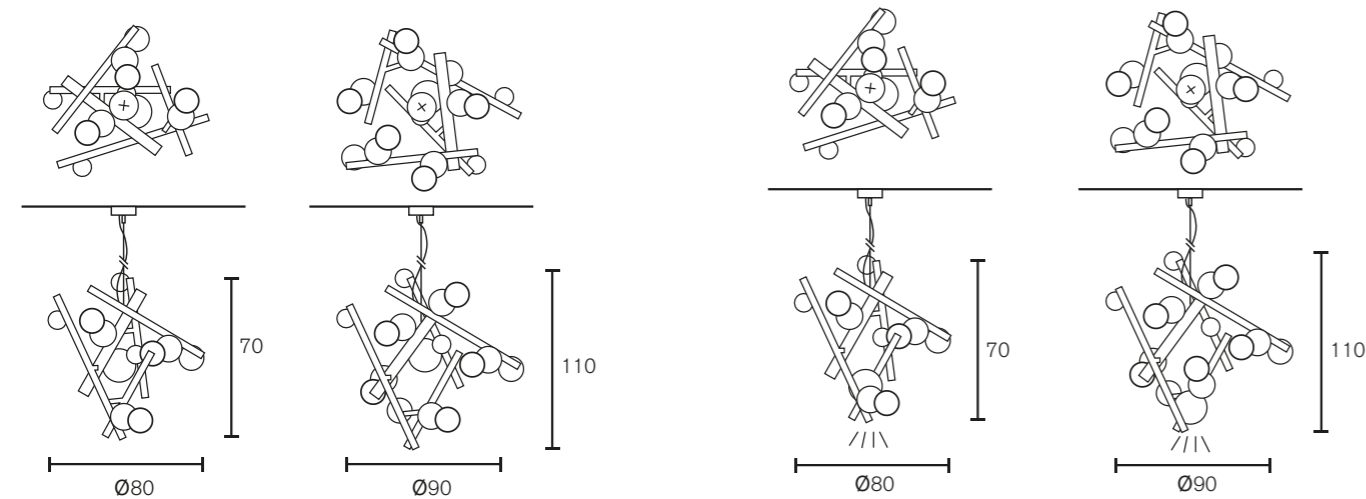

All chandeliers are supplied with 3 meter steel cable, 3 meter electrical cable and a ceiling shade. The beam angle for our GU10 spotlights is 60°.

Technical information

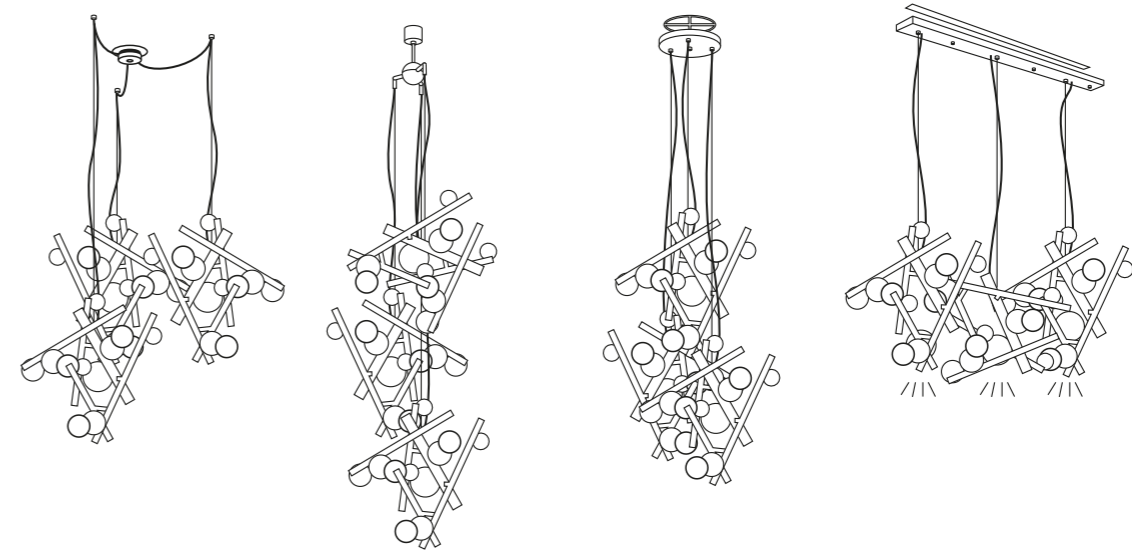

Element

Art.nr.	Dimensions	Light bulb	Weight	Finish
GALDL45BLM	L.40xW.45xH.50 cm	1x E27	5.0 kg	1x GU10 spot downlight, black matt finish
GALDL45N	L.40xW.45xH.50 cm	1x E27	5.0 kg	1x GU10 spot downlight, nickel finish
GALDL45BR	L.40xW.45xH.50 cm	1x E27	5.0 kg	1x GU10 spot downlight, brass finish
GALDL45BRBUR	L.40xW.45xH.50 cm	1x E27	5.0 kg	1x GU10 spot downlight, brass burnished finish
GALDL45NA	L.40xW.45xH.50 cm	1x E27	5.0 kg	1x GU10 spot downlight, nickel aged finish

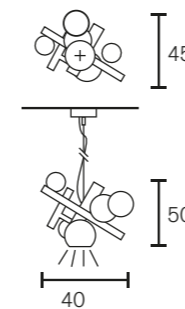

All elements are supplied with 3 meter steel cable, 3 meter electrical cable and a ceiling shade. The beam angle for our GU10 spotlights is 60°.

Technical information

Hanging Lamp Long

Art.nr.	Dimensions	Light bulb	Weight	Finish
GALHL120BLM	L.120xW.50xH.40 cm	3x E27	15,0 kg	3x GU10 spot downlight, black matt finish
GALHL120N	L.120xW.50xH.40 cm	3x E27	15,0 kg	3x GU10 spot downlight, nickel finish
GALHL120BR	L.120xW.50xH.40 cm	3x E27	15,0 kg	3x GU10 spot downlight, brass finish
GALHL120BRBUR	L.120xW.50xH.40 cm	3x E27	15,0 kg	3x GU10 spot downlight, brass burnished finish
GALHL120NA	L.120xW.50xH.40 cm	3x E27	15,0 kg	3x GU10 spot downlight, nickel aged finish
GALHL140BLM	L.140xW.50xH.40 cm	4x E27	20,0 kg	3x GU10 spot downlight, black matt finish
GALHL140N	L.140xW.50xH.40 cm	4x E27	20,0 kg	3x GU10 spot downlight, nickel finish
GALHL140BR	L.140xW.50xH.40 cm	4x E27	20,0 kg	3x GU10 spot downlight, brass finish
GALHL140BRBUR	L.140xW.50xH.40 cm	4x E27	20,0 kg	3x GU10 spot downlight, brass burnished finish
GALHL140NA	L.140xW.50xH.40 cm	4x E27	20,0 kg	3x GU10 spot downlight, nickel aged finish
GALHL160BLM	L.160xW.50xH.40 cm	4x E27	25,0 kg	4x GU10 spot downlight, black matt finish
GALHL160N	L.160xW.50xH.40 cm	4x E27	25,0 kg	4x GU10 spot downlight, nickel finish
GALHL160BR	L.160xW.50xH.40 cm	4x E27	25,0 kg	4x GU10 spot downlight, brass finish
GALHL160BRBUR	L.160xW.50xH.40 cm	4x E27	25,0 kg	4x GU10 spot downlight, brass burnished finish
GALHL160NA	L.160xW.50xH.40 cm	4x E27	25,0 kg	4x GU10 spot downlight, nickel aged finish
GALHL180BLM	L.180xW.50xH.40 cm	4x E27	30,0 kg	4x GU10 spot downlight, black matt finish
GALHL180N	L.180xW.50xH.40 cm	4x E27	30,0 kg	4x GU10 spot downlight, nickel finish
GALHL180BR	L.180xW.50xH.40 cm	4x E27	30,0 kg	4x GU10 spot downlight, brass finish
GALHL180BRBUR	L.180xW.50xH.40 cm	4x E27	30,0 kg	4x GU10 spot downlight, brass burnished finish
GALHL180NA	L.180xW.50xH.40 cm	4x E27	30,0 kg	4x GU10 spot downlight, nickel aged finish
GALHL200BLM	L.200xW.50xH.40 cm	5x E27	35,0 kg	5x GU10 spot downlight, black matt finish
GALHL200N	L.200xW.50xH.40 cm	5x E27	35,0 kg	5x GU10 spot downlight, nickel finish
GALHL200BR	L.200xW.50xH.40 cm	5x E27	35,0 kg	5x GU10 spot downlight, brass finish
GALHL200BRBUR	L.200xW.50xH.40 cm	5x E27	35,0 kg	5x GU10 spot downlight, brass burnished finish
GALHL200NA	L.200xW.50xH.40 cm	5x E27	35,0 kg	5x GU10 spot downlight, nickel aged finish

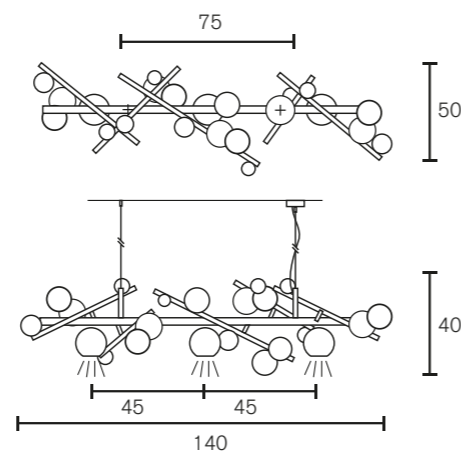
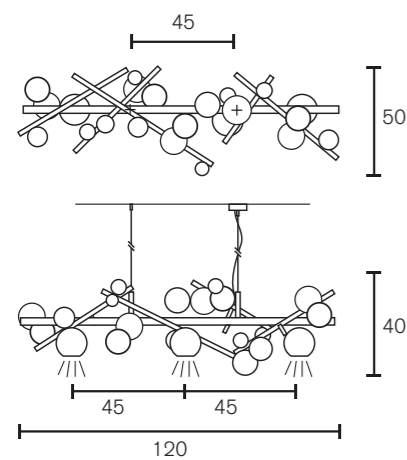

Technical information

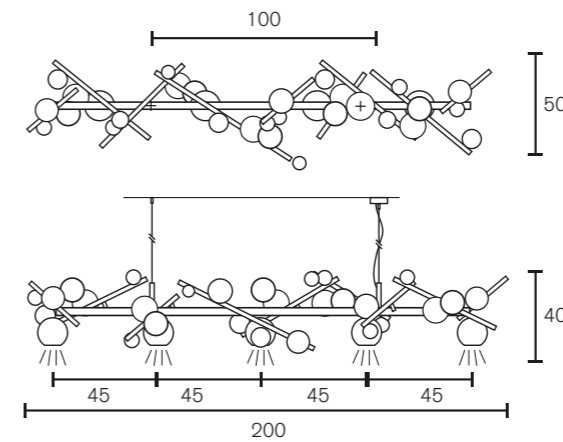
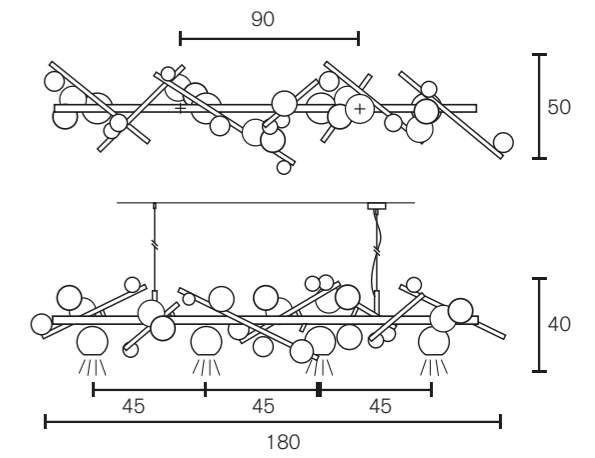
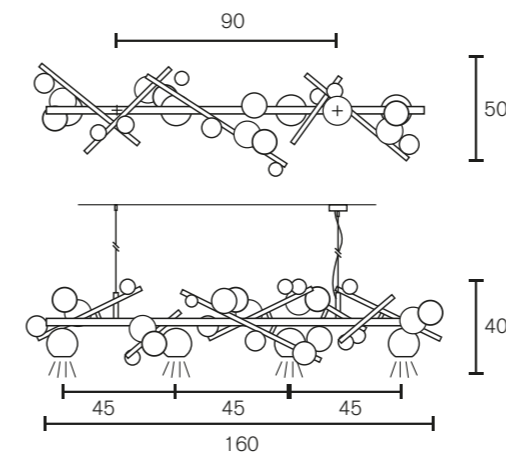

All hanging lamps are supplied with 3 meter steel cable, 3 meter electrical cable and a ceiling shade. The beam angle for our GU10 spotlights is 60°.

All hanging lamps are supplied with 3 meter steel cable, 3 meter electrical cable and a ceiling shade. The beam angle for our GU10 spotlights is 60°.

Technical information

Collection Orpheus 2019

Element

Art.nr.	Dimensions	Light bulb	Weight	Finish
OR30-CANDBRA	Ø30xH.57 cm	1x E14	3,0 kg	1x GU10 spot downlight, brass aged finish

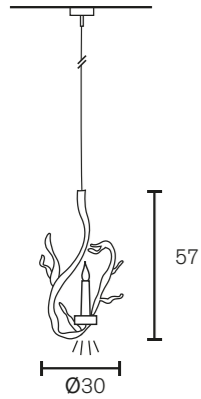

Art Element

Art.nr.	Dimensions	Light bulb	Weight	Finish
ORC35BDP-NYMR	Ø35xH.85 cm	1x GU10	4.0 kg	cast bronze dark patina with Nymphenburg rose
ORC35BDP-AM	Ø35xH.85 cm	1x GU10	4.0 kg	cast bronze dark patina with amethyst
ORC35BDP-PYR	Ø35xH.85 cm	1x GU10	4.0 kg	cast bronze dark patina with pyrite

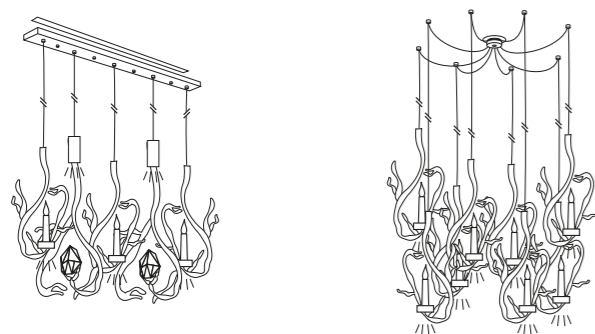
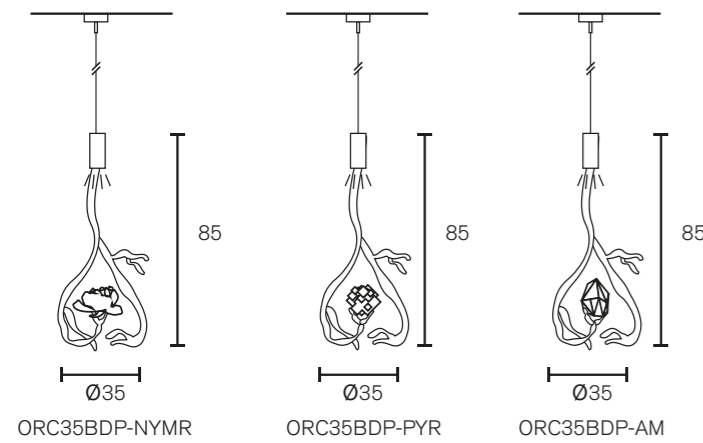

Due to the scarcity of (semi)precious stones and minerals, we need to check availability before an order can be confirmed.
 All (semi)precious stones differ from each other in size and shape.
 All elements and art elements are supplied with 3 meter steel cable, 3 meter electrical cable and a ceiling shade.

Technical information

Collection Louise 2018

Lanterns

Art.nr.	Finish
GLLOBRO22	Louise, Glass Bronze Ø22cm
GLLOGREY22	Louise, Glass Grey Ø22cm
GLLOIRI22	Louise, Glass Iridescent Ø22cm
GLLOSAT22	Louise, Glass Clear Satin Ø22cm

Hanging Lamp

Art.nr.	Dimensions	Light bulb	Weight	Finish
LO1BLM	Ø22xH.36 cm	1x E27	2.4 kg	black matt finish
LO1N	Ø22xH.36 cm	1x E27	2.4 kg	nickel finish
LO1BR	Ø22xH.36 cm	1x E27	2.4 kg	brass finish
LO1BRBUR	Ø22xH.36 cm	1x E27	2,4 kg	brass burnished finish
LO1NA	Ø22xH.36 cm	1x E27	2.4 kg	nickel aged finish
LO3BLM	Ø60xH.70 cm	3x E27	11.5 kg	black matt finish
LO3N	Ø60xH.70 cm	3x E27	11.5 kg	nickel finish
LO3BR	Ø60xH.70 cm	3x E27	11.5 kg	brass finish
LO3BRBUR	Ø60xH.70 cm	3x E27	11,5 kg	brass burnished finish
LO3NA	Ø60xH.70 cm	3x E27	11.5 kg	nickel aged finish
LO4BLM	Ø60xH.78 cm	4x E27	14.0 kg	black matt finish
LO4N	Ø60xH.78 cm	4x E27	14.0 kg	nickel finish
LO4BR	Ø60xH.78 cm	4x E27	14.0 kg	brass finish
LO4BRBUR	Ø60xH.78 cm	4x E27	14.0 kg	brass burnished finish
LO4NA	Ø60xH.78 cm	4x E27	14.0 kg	nickel aged finish

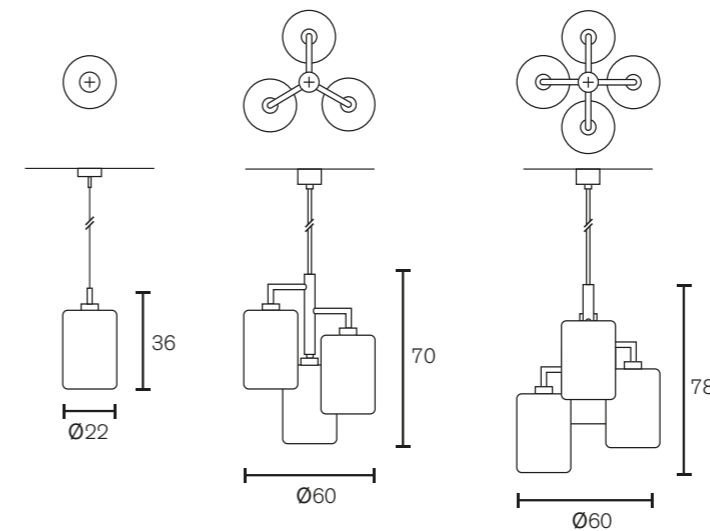

LO1 is supplied with 3 meter electrical cable and a ceiling shade. All chandeliers are supplied with 2 meter stem and a ceiling shade.

The lanterns are available in 4 different types of glass: bronze, clear satin, grey and iridescent.

Technical information

Hanging Lamp

Art.nr.	Dimensions	Light bulb	Weight	Finish
LO5BLM	Ø60xH.105 cm	5x E27	18.0 kg	black matt finish
LO5N	Ø60xH.105 cm	5x E27	18.0 kg	nickel finish
LO5BR	Ø60xH.105 cm	5x E27	18.0 kg	brass finish
LO5BRBUR	Ø60xH.105 cm	5x E27	18.0 kg	brass burnished finish
LO5NA	Ø60xH.105 cm	5x E27	18.0 kg	nickel aged finish
LO8BLM	Ø60xH.205 cm	8x E27	28.0 kg	black matt finish
LO8N	Ø60xH.205 cm	8x E27	28.0 kg	nickel finish
LO8BR	Ø60xH.205 cm	8x E27	28.0 kg	brass finish
LO8BRBUR	Ø60xH.205 cm	8x E27	28.0 kg	brass burnished finish
LO8NA	Ø60xH.205 cm	8x E27	28.0 kg	nickel aged finish

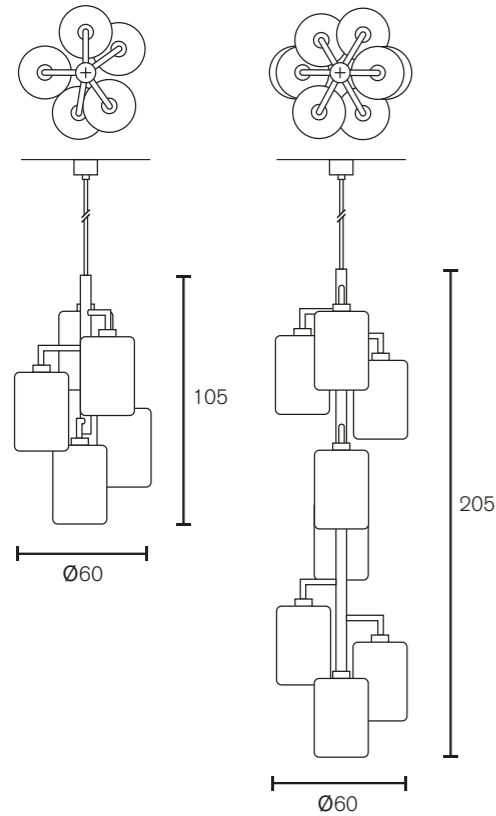

The lanterns are available in 4 different types of glass: bronze, clear satin, grey and iridescent.
All hanging lamps are supplied with 2 meter stem and a ceiling shade

Technical information

Chandelier Round

Art.nr.	Dimensions	Light bulb	Weight	Finish
LOC60BLM	Ø60xH.53 cm	5x E27	25.0 kg	black matt finish
LOC60N	Ø60xH.53 cm	5x E27	25.0 kg	nickel finish
LOC60BR	Ø60xH.53 cm	5x E27	25.0 kg	brass finish
LOC60BRBUR	Ø60xH.53 cm	5x E27	25.0 kg	brass burnished finish
LOC60NA	Ø60xH.53 cm	5x E27	25.0 kg	nickel aged finish
LOC80BLM	Ø82xH.53 cm	7x E27	25.0 kg	black matt finish
LOC80N	Ø82xH.53 cm	7x E27	25.0 kg	nickel finish
LOC80BR	Ø82xH.53 cm	7x E27	25.0 kg	brass finish
LOC80BRBUR	Ø82xH.53 cm	7x E27	25.0 kg	brass burnished finish
LOC80NA	Ø82xH.53 cm	7x E27	25.0 kg	nickel aged finish
LOC100BLM	Ø100xH.60 cm	8x E27	30.0 kg	black matt finish
LOC100N	Ø100xH.60 cm	8x E27	30.0 kg	nickel finish
LOC100BR	Ø100xH.60 cm	8x E27	30.0 kg	brass finish
LOC100BRBUR	Ø100xH.60 cm	8x E27	30.0 kg	brass burnished finish
LOC100NA	Ø100xH.60 cm	8x E27	30.0 kg	nickel aged finish
LOC120BLM	Ø120xH.65 cm	13x E27	40,0 kg	black matt finish
LOC120N	Ø120xH.65 cm	13x E27	40,0 kg	nickel finish
LOC120BR	Ø120xH.65 cm	13x E27	40,0 kg	brass finish
LOC120BRBUR	Ø120xH.65 cm	13x E27	40,0 kg	brass burnished finish
LOC120NA	Ø120xH.65 cm	13x E27	40,0 kg	nickel aged finish

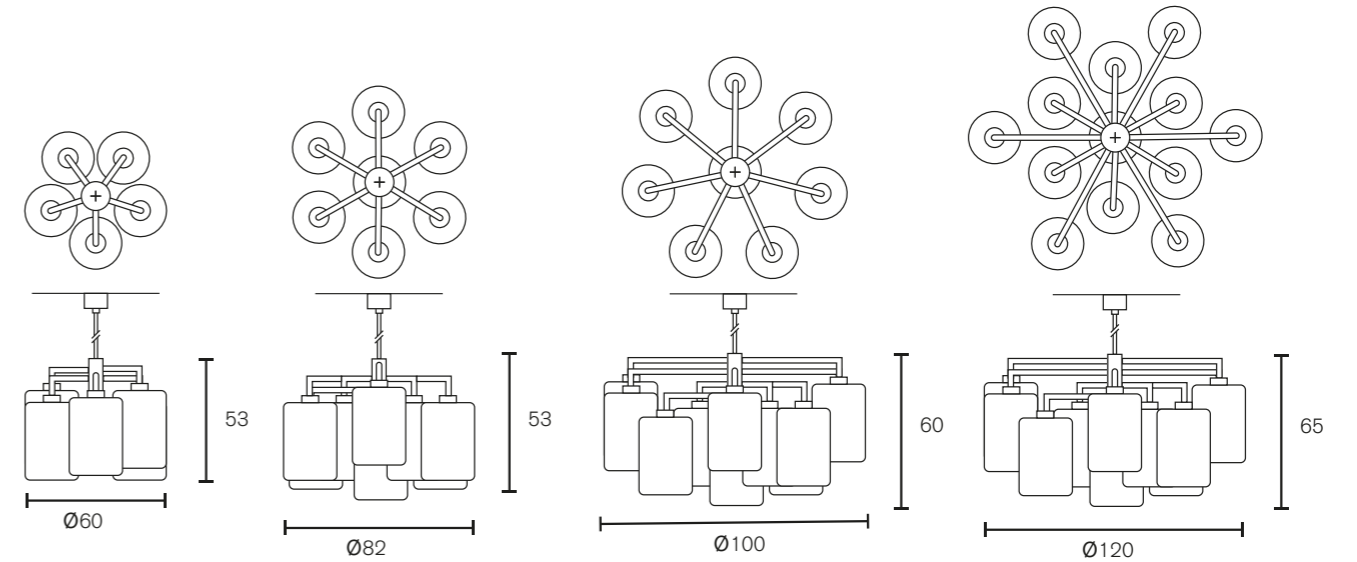

The lanterns are available in 4 different types of glass: bronze, clear satin, grey and iridescent.
All chandeliers are supplied with 2 meter stem and a ceiling shade

Technical information

Hanging Lamp Long

Art.nr.	Dimensions	Light bulb	Weight	Finish
LOHL120BLM	L.120xW.55xH.62 cm	8x E27	28.0 kg	black matt finish
LOHL120N	L.120xW.55xH.62 cm	8x E27	28.0 kg	nickel finish
LOHL120BR	L.120xW.55xH.62 cm	8x E27	28.0 kg	brass finish
LOHL120BRBUR	L.120xW.55xH.62 cm	8x E27	28.0 kg	brass burnished finish
LOHL120NA	L.120xW.55xH.62 cm	8x E27	28.0 kg	nickel aged finish
LOHL140BLM	L.140xW.55xH.62 cm	10x E27	32.0 kg	black matt finish
LOHL140N	L.140xW.55xH.62 cm	10x E27	32.0 kg	nickel finish
LOHL140BR	L.140xW.55xH.62 cm	10x E27	32.0 kg	brass finish
LOHL140BRBUR	L.140xW.55xH.62 cm	10x E27	32.0 kg	brass burnished finish
LOHL140NA	L.140xW.55xH.62 cm	10x E27	32.0 kg	nickel aged finish
LOHL160BLM	L.160xW.55xH.62 cm	10x E27	35.0 kg	black matt finish
LOHL160N	L.160xW.55xH.62 cm	10x E27	35.0 kg	nickel finish
LOHL160BR	L.160xW.55xH.62 cm	10x E27	35.0 kg	brass finish
LOHL160BRBUR	L.160xW.55xH.62 cm	10x E27	35.0 kg	brass burnished finish
LOHL160NA	L.160xW.55xH.62 cm	10x E27	35.0 kg	nickel aged finish
LOHL180BLM	L.180xW.55xH.62 cm	12x E27	42.0 kg	black matt finish
LOHL180N	L.180xW.55xH.62 cm	12x E27	42.0 kg	nickel finish
LOHL180BR	L.180xW.55xH.62 cm	12x E27	42.0 kg	brass finish
LOHL180BRBUR	L.180xW.55xH.62 cm	12x E27	42.0 kg	brass burnished finish
LOHL180NA	L.180xW.55xH.62 cm	12x E27	42.0 kg	nickel aged finish

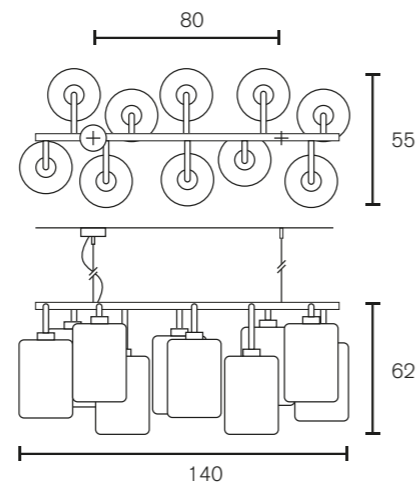
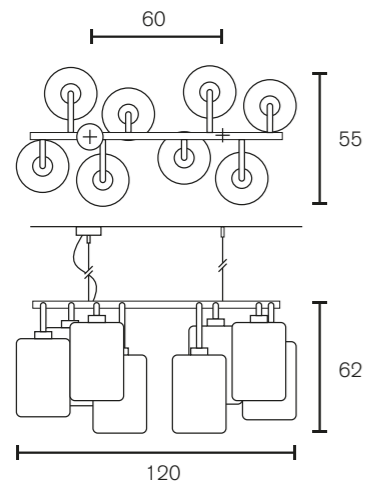

The lanterns are available in 4 different types of glass: bronze, clear satin, grey and iridescent.
All hanging lamps are supplied with 3 meter steel cable and a ceiling shade

Technical information

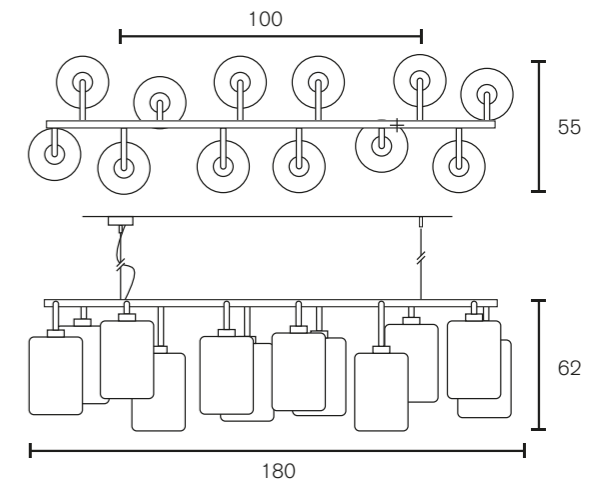
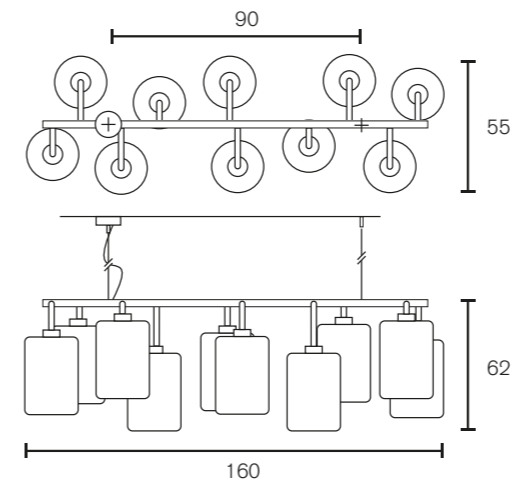

Ceiling Lamp Round

Art.nr.	Dimensions	Light bulb	Weight	Finish
LOP60BLM	Ø60xH.50 cm	3x E27	10.0 kg	black matt finish
LOP60N	Ø60xH.50 cm	3x E27	10.0 kg	nickel finish
LOP60BR	Ø60xH.50 cm	3x E27	10.0 kg	brass finish
LOP60BRBUR	Ø60xH.50 cm	3x E27	10.0 kg	brass burnished finish
LOP60NA	Ø60xH.50 cm	3x E27	10.0 kg	nickel aged finish
LOP80BLM	Ø80xH.50 cm	4x E27	15.0 kg	black matt finish
LOP80N	Ø80xH.50 cm	4x E27	15.0 kg	nickel finish
LOP80BR	Ø80xH.50 cm	4x E27	15.0 kg	brass finish
LOP80BRBUR	Ø80xH.50 cm	4x E27	15.0 kg	brass burnished finish
LOP80NA	Ø80xH.50 cm	4x E27	15.0 kg	nickel aged finish
LOP100BLM	Ø100xH.55 cm	5x E27	20.0 kg	black matt finish
LOP100N	Ø100xH.55 cm	5x E27	20.0 kg	nickel finish
LOP100BR	Ø100xH.55 cm	5x E27	20.0 kg	brass finish
LOP100BRBUR	Ø100xH.55 cm	5x E27	20.0 kg	brass burnished finish
LOP100NA	Ø100xH.55 cm	5x E27	20.0 kg	nickel aged finish

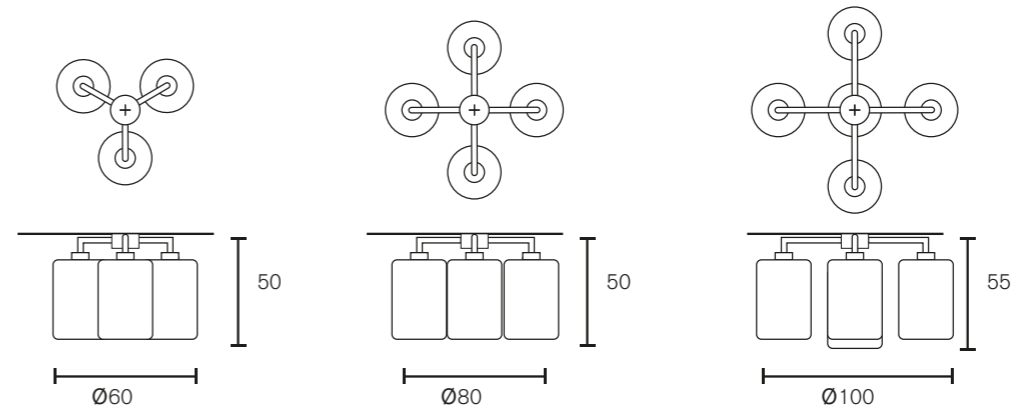

The lanterns are available in 4 different types of glass: bronze, clear satin, grey and iridescent.
All hanging lamps are supplied with 3 meter steel cable, 3 meter electrical cable and a ceiling shade.

Technical information

Floor Lamp

Art.nr.	Dimensions	Light bulb	Weight	Finish
LOF180BLM	Ø30xH.182 cm	1x E27	11.0 kg	black matt finish
LOF180N	Ø30xH.182 cm	1x E27	11.0 kg	nickel finish
LOF180BR	Ø30xH.182 cm	1x E27	11.0 kg	brass finish
LOF180BRBUR	Ø30xH.182 cm	1x E27	11.0 kg	brass burnished finish
LOF180NA	Ø30xH.182 cm	1x E27	11.0 kg	nickel aged finish
LOF200BLM	Ø50xH.202 cm	3x E27	16.0 kg	black matt finish
LOF200N	Ø50xH.202 cm	3x E27	16.0 kg	nickel finish
LOF200BR	Ø50xH.202 cm	3x E27	16.0 kg	brass finish
LOF200BRBUR	Ø50xH.202 cm	3x E27	16.0 kg	brass burnished finish
LOF200NA	Ø50xH.202 cm	3x E27	16.0 kg	nickel aged finish

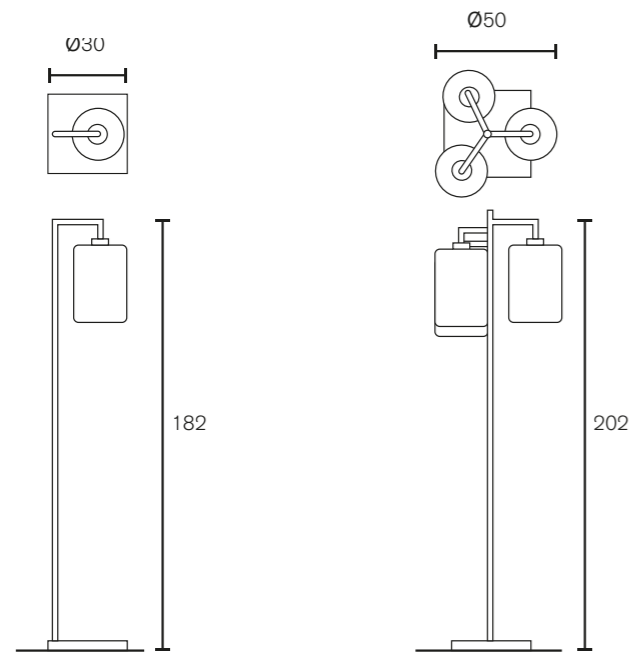

The lanterns are available in 4 different types of glass: bronze, clear satin, grey and iridescent.
All floor lamps are supplied with a floor dimmer.

Technical information

Table Lamp

Art.nr.	Dimensions	Light bulb	Weight	Finish
LOT75BLM	L.35xW.22xH.76 cm	1x E27	8.0 kg	black matt finish
LOT75N	L.35xW.22xH.76 cm	1x E27	8.0 kg	nickel finish
LOT75BR	L.35xW.22xH.76 cm	1x E27	8.0 kg	brass finish
LOT75BRBUR	L.35xW.22xH.76 cm	1x E27	8.0 kg	brass burnished finish
LOT75NA	L.35xW.22xH.76 cm	1x E27	8.0 kg	nickel aged finish

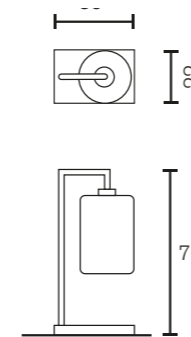

Wall Lamp

Art.nr.	Dimensions	Light bulb	Weight	Finish
LOW60BLM	L.22xW.30xH.58 cm	1x E27	4.0 kg	black matt finish
LOW60N	L.22xW.30xH.58 cm	1x E27	4.0 kg	nickel finish
LOW60BR	L.22xW.30xH.58 cm	1x E27	4.0 kg	brass finish
LOW60BRBUR	L.22xW.30xH.58 cm	1x E27	4.0 kg	brass burnished finish
LOW60NA	L.22xW.30xH.58 cm	1x E27	4.0 kg	nickel aged finish

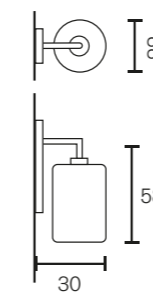

The lanterns are available in 4 different types of glass: bronze, clear satin, grey and iridescent.
All table lamps are delivered with a table dimmer.

Technical information

Collection Ersa 2018

Chandelier

Art.nr.	Dimensions	Light bulb	Weight	Finish
ERSA4BLM-GLIRI	L.80xW.55xH.50 cm	4x E27	11.0 kg	black matt finish, glass sphere iridescent
ERSA4WM-GLIRI	L.80xW.55xH.50 cm	4x E27	11.0 kg	white matt finish, glass sphere iridescent
ERSA4B-GLIRI	L.80xW.55xH.50 cm	4x E27	11.0 kg	bronze finish, glass sphere iridescent
ERSA4N-GLIRI	L.80xW.55xH.50 cm	4x E27	11.0 kg	nickel finish, glass sphere iridescent
ERSA4BR-GLIRI	L.80xW.55xH.50 cm	4x E27	11.0 kg	brass finish, glass sphere iridescent
ERSA4BRBUR-GLIRI	L.80xW.55xH.50 cm	4x E27	11.0 kg	brass burnished finish, glass sphere iridescent
ERSAC80BLM-GLIRI	Ø80xH.65 cm	5x E27	15.0 kg	black matt finish, glass sphere iridescent
ERSAC80WM-GLIRI	Ø80xH.65 cm	5x E27	15.0 kg	white matt finish, glass sphere iridescent
ERSAC80B-GLIRI	Ø80xH.65 cm	5x E27	15.0 kg	bronze finish, glass sphere iridescent
ERSAC80N-GLIRI	Ø80xH.65 cm	5x E27	15.0 kg	nickel finish, glass sphere iridescent
ERSAC80BR-GLIRI	Ø80xH.65 cm	5x E27	15.0 kg	brass finish, glass sphere iridescent
ERSAC80BRBUR-GLIRI	Ø80xH.65 cm	5x E27	15.0 kg	brass burnished finish, glass sphere iridescent
ERSAC100BLM-GLIRI	Ø110xH.75 cm	7x E27	23.0 kg	black matt finish, glass sphere iridescent
ERSAC100WM-GLIRI	Ø110xH.75 cm	7x E27	23.0 kg	white matt finish, glass sphere iridescent
ERSAC100B-GLIRI	Ø110xH.75 cm	7x E27	23.0 kg	bronze finish, glass sphere iridescent
ERSAC100N-GLIRI	Ø110xH.75 cm	7x E27	23.0 kg	nickel finish, glass sphere iridescent
ERSAC100BR-GLIRI	Ø110xH.75 cm	7x E27	23.0 kg	brass finish, glass sphere iridescent
ERSAC100BRBUR-GLIRI	Ø110xH.75 cm	7x E27	23.0 kg	brass burnished finish, glass sphere iridescent
ERSAC120BLM-GLIRI	Ø120xH.70 cm	9x E27	32,0 kg	black matt finish, glass sphere iridescent
ERSAC120WM-GLIRI	Ø120xH.70 cm	9x E27	32,0 kg	white matt finish, glass sphere iridescent
ERSAC120B-GLIRI	Ø120xH.70 cm	9x E27	32,0 kg	bronze finish, glass sphere iridescent
ERSAC120N-GLIRI	Ø120xH.70 cm	9x E27	32,0 kg	nickel finish, glass sphere iridescent
ERSAC120BR-GLIRI	Ø120xH.70 cm	9x E27	32,0 kg	brass finish, glass sphere iridescent
ERSAC120BRBUR-GLIRI	Ø120xH.70 cm	9x E27	32,0 kg	brass burnished finish, glass sphere iridescent
ERSAC140BLM-GLIRI	Ø140xH.80 cm	11x E27	40,0 kg	black matt finish, glass sphere iridescent
ERSAC140WM-GLIRI	Ø140xH.80 cm	11x E27	40,0 kg	white matt finish, glass sphere iridescent
ERSAC140B-GLIRI	Ø140xH.80 cm	11x E27	40,0 kg	bronze finish, glass sphere iridescent
ERSAC140N-GLIRI	Ø140xH.80 cm	11x E27	40,0 kg	nickel finish, glass sphere iridescent
ERSAC140BR-GLIRI	Ø140xH.80 cm	11x E27	40,0 kg	brass finish, glass sphere iridescent
ERSAC140BRBUR-GLIRI	Ø140xH.80 cm	11x E27	40,0 kg	brass burnished finish, glass sphere iridescent

Standard the ERSA will be delivered with iridescent glass spheres. Other options are bronze translucent or clear glass spheres.
All chandeliers are supplied with 1,7 meter chain, 2 meter electrical cable and a ceiling shade.

Technical information

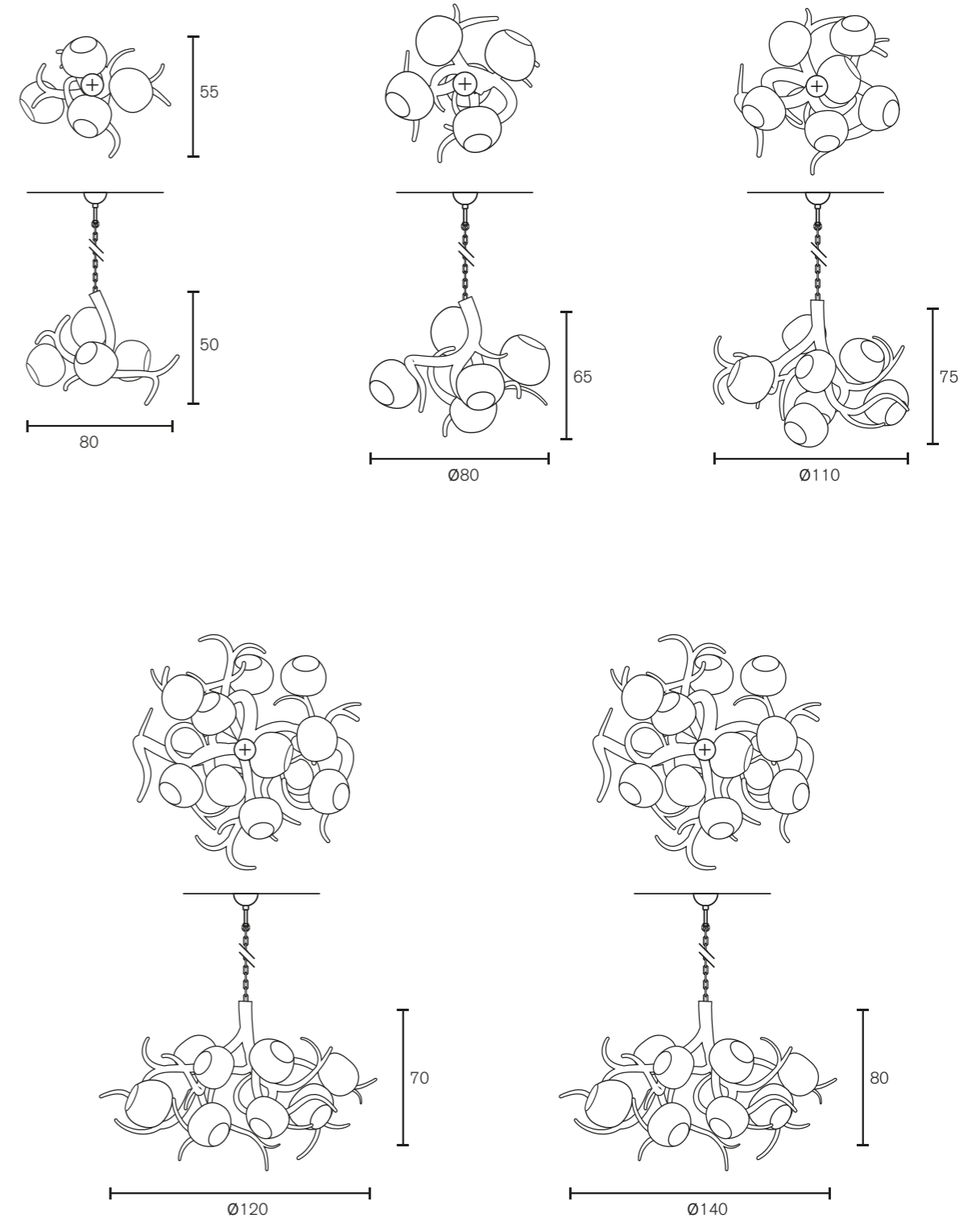

Standard the ERSA will be delivered with iridescent glass spheres. Other options are bronze translucent or clear glass spheres.
All chandeliers are supplied with 1,7 meter chain, 2 meter electrical cable and a ceiling shade.

Technical information

Chandelier Conical

Art.nr.	Dimensions	Light bulb	Weight	Finish
ERSACC90BLM-GLIRI	Ø90xH.120 cm	9x E27	35.0 kg	black matt finish, glass sphere iridescent
ERSACC90WM-GLIRI	Ø90xH.120 cm	9x E27	35,0 kg	white matt finish, glass sphere iridescent
ERSACC90B-GLIRI	Ø90xH.120 cm	9x E27	35.0 kg	bronze finish, glass sphere iridescent
ERSACC90N-GLIRI	Ø90xH.120 cm	9x E27	35.0 kg	nickel finish, glass sphere iridescent
ERSACC90BR-GLIRI	Ø90xH.120 cm	9x E27	35.0 kg	brass finish, glass sphere iridescent
ERSACC90BRBUR-GLIRI	Ø90xH.120 cm	9x E27	35.0 kg	brass burnished finish, glass sphere iridescent
ERSACC110BLM-GLIRI	Ø110xH.130 cm	9x E27	45.0 kg	black matt finish, glass sphere iridescent
ERSACC110WM-GLIRI	Ø110xH.130 cm	9x E27	45,0 kg	white matt finish, glass sphere iridescent
ERSACC110B-GLIRI	Ø110xH.130 cm	9x E27	45.0 kg	bronze finish, glass sphere iridescent
ERSACC110N-GLIRI	Ø110xH.130 cm	9x E27	45.0 kg	nickel finish, glass sphere iridescent
ERSACC110BR-GLIRI	Ø110xH.130 cm	9x E27	45.0 kg	brass finish, glass sphere iridescent
ERSACC110BRBUR-GLIRI	Ø110xH.130 cm	9x E27	45.0 kg	brass burnished finish, glass sphere iridescent
ERSACC130BLM-GLIRI	Ø120xH.140 cm	11x E27	55.0 kg	black matt finish, glass sphere iridescent
ERSACC130WM-GLIRI	Ø120xH.140 cm	11x E27	55,0 kg	white matt finish, glass sphere iridescent
ERSACC130B-GLIRI	Ø120xH.140 cm	11x E27	55.0 kg	bronze finish, glass sphere iridescent
ERSACC130N-GLIRI	Ø120xH.140 cm	11x E27	55.0 kg	nickel finish, glass sphere iridescent
ERSACC130BR-GLIRI	Ø120xH.140 cm	11x E27	55.0 kg	brass finish, glass sphere iridescent
ERSACC130BRBUR-GLIRI	Ø120xH.140 cm	11x E27	55.0 kg	brass burnished finish, glass sphere iridescent

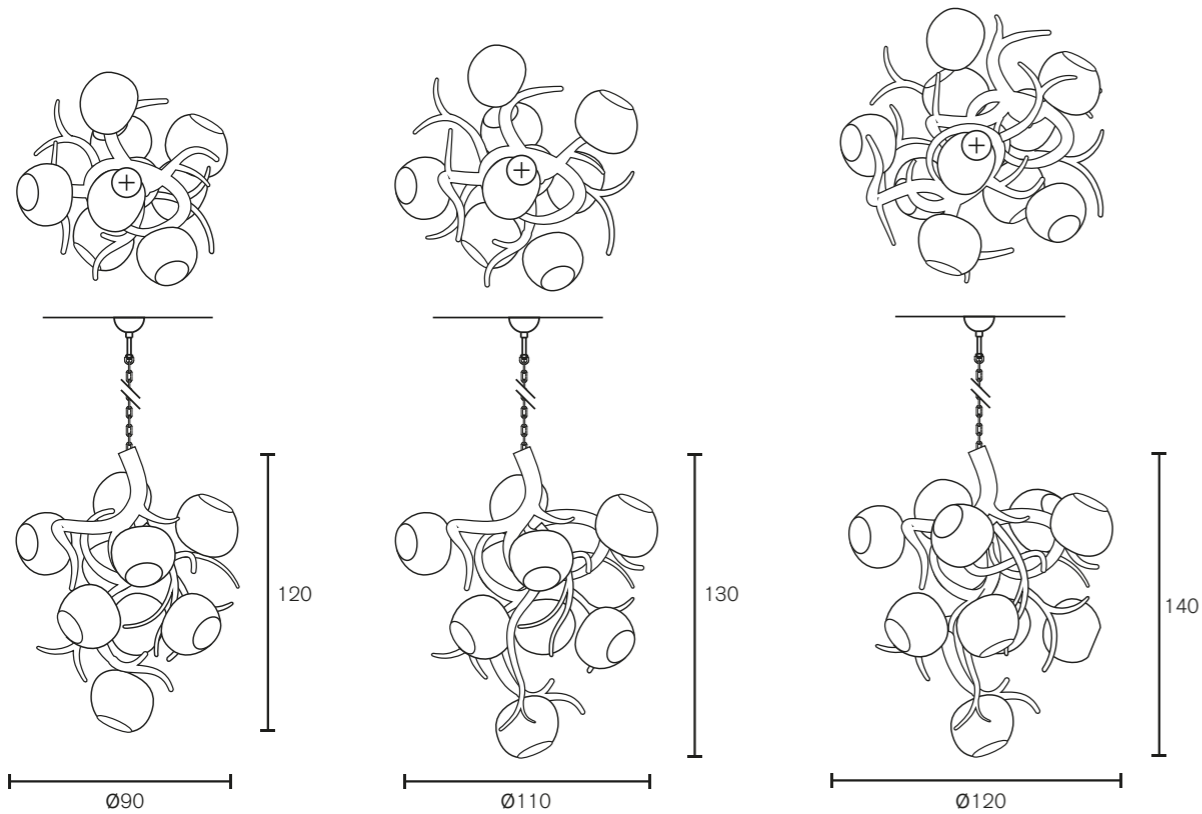

Standard the ERSA will be delivered with iridescent glass spheres. Other options are bronze translucent or clear glass spheres.
All chandeliers are supplied with 1,7 meter chain, 2 meter electrical cable and a ceiling shade.

Technical information

Chandelier Oval

Art.nr.	Dimensions	Light bulb	Weight	Finish
ERSAOC120BLM-GLIRI	L.120xW.60xH.70 cm	5x E27	18.0 kg	black matt finish, glass sphere iridescent
ERSAOC120WM-GLIRI	L.120xW.60xH.70 cm	5x E27	18,0 kg	white matt finish, glass sphere iridescent
ERSAOC120B-GLIRI	L.120xW.60xH.70 cm	5x E27	18.0 kg	bronze finish, glass sphere iridescent
ERSAOC120N-GLIRI	L.120xW.60xH.70 cm	5x E27	18.0 kg	nickel finish, glass sphere iridescent
ERSAOC120BR-GLIRI	L.120xW.60xH.70 cm	5x E27	18.0 kg	brass finish, glass sphere iridescent
ERSAOC120BRBUR-GLIRI	L.120xW.60xH.70 cm	5x E27	18.0 kg	brass burnished finish, glass sphere iridescent
ERSAOC140BLM-GLIRI	L.140xW.60xH.70 cm	7x E27	20.0 kg	black matt finish, glass sphere iridescent
ERSAOC140WM-GLIRI	L.140xW.60xH.70 cm	7x E27	20,0 kg	white matt finish, glass sphere iridescent
ERSAOC140B-GLIRI	L.140xW.60xH.70 cm	7x E27	20.0 kg	bronze finish, glass sphere iridescent
ERSAOC140N-GLIRI	L.140xW.60xH.70 cm	7x E27	20.0 kg	nickel finish, glass sphere iridescent
ERSAOC140BR-GLIRI	L.140xW.60xH.70 cm	7x E27	20.0 kg	brass finish, glass sphere iridescent
ERSAOC140BRBUR-GLIRI	L.140xW.60xH.70 cm	7x E27	20.0 kg	brass burnished finish, glass sphere iridescent

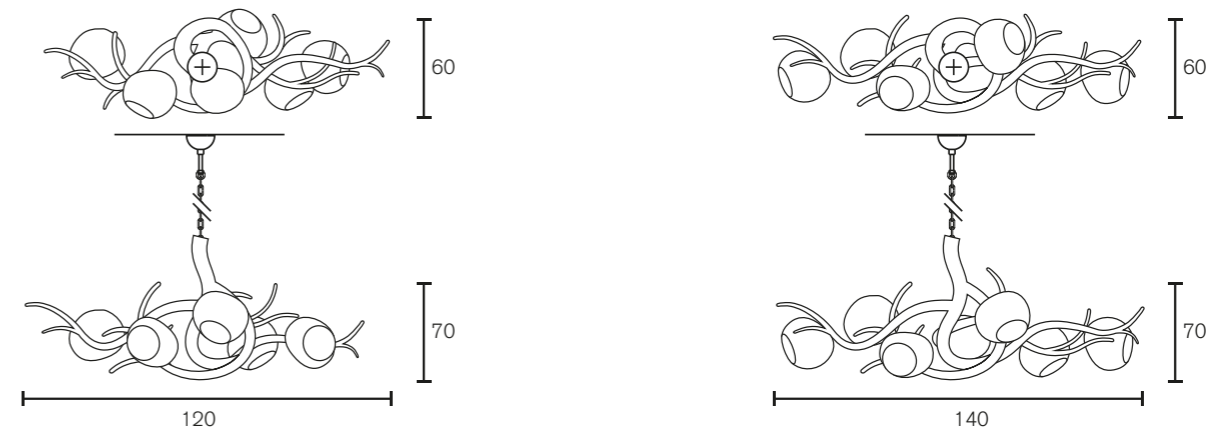

Standard the ERSA will be delivered with iridescent glass spheres. Other options are bronze translucent or clear glass spheres.
All chandeliers are supplied with 1,7 meter chain, 2 meter electrical cable and a ceiling shade.

Technical information

Chandelier Oval

Art.nr.	Dimensions	Light bulb	Weight	Finish
ERSAOC160BLM-GLIRI	L.160xW.60xH.70 cm	8x E27	30,0 kg	black matt finish, glass sphere iridescent
ERSAOC160WM-GLIRI	L.160xW.60xH.70 cm	8x E27	30,0 kg	white matt finish, glass sphere iridescent
ERSAOC160B-GLIRI	L.160xW.60xH.70 cm	8x E27	30,0 kg	bronze finish, glass sphere iridescent
ERSAOC160N-GLIRI	L.160xW.60xH.70 cm	8x E27	30,0 kg	nickel finish, glass sphere iridescent
ERSAOC160BR-GLIRI	L.160xW.60xH.70 cm	8x E27	30,0 kg	brass finish, glass sphere iridescent
ERSAOC160BRBUR-GLIRI	L.160xW.60xH.70 cm	8x E27	30,0 kg	brass burnished finish, glass sphere iridescent
ERSAOC180BLM-GLIRI	L.180xW.60xH.70 cm	9x E27	40,0 kg	black matt finish, glass sphere iridescent
ERSAOC180WM-GLIRI	L.180xW.60xH.70 cm	9x E27	40,0 kg	white matt finish, glass sphere iridescent
ERSAOC180B-GLIRI	L.180xW.60xH.70 cm	9x E27	40,0 kg	bronze finish, glass sphere iridescent
ERSAOC180N-GLIRI	L.180xW.60xH.70 cm	9x E27	40,0 kg	nickel finish, glass sphere iridescent
ERSAOC180BR-GLIRI	L.180xW.60xH.70 cm	9x E27	40,0 kg	brass finish, glass sphere iridescent
ERSAOC180BRBUR-GLIRI	L.180xW.60xH.70 cm	9x E27	40,0 kg	brass burnished finish, glass sphere iridescent

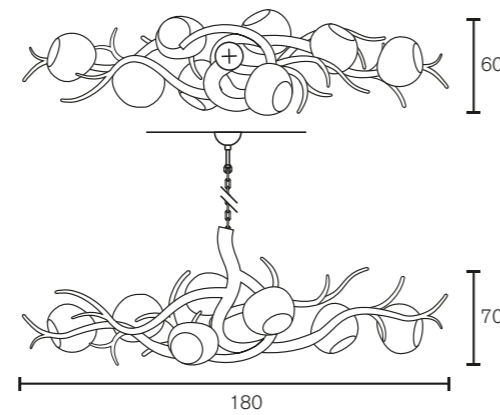
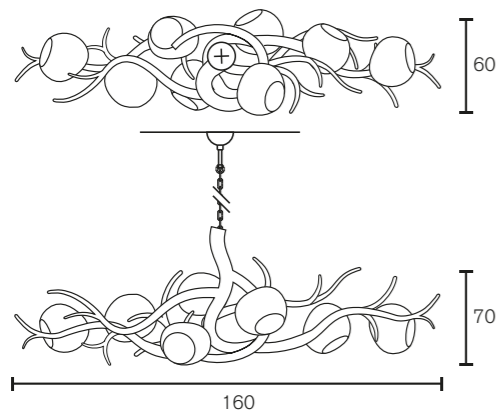

Standard the ERSA will be delivered with iridescent glass spheres. Other options are bronze translucent or clear glass spheres.
All chandeliers are supplied with 1,7 meter chain, 2 meter electrical cable and a ceiling shade.

Technical information

Chandelier Vertical

Art.nr.	Dimensions	Light bulb	Weight	Finish
ERSAV110BLM-GLIRI	Ø60xH.110 cm	5x E27	15,0 kg	black matt finish, glass sphere iridescent
ERSAV110WM-GLIRI	Ø60xH.110 cm	5x E27	15,0 kg	white matt finish, glass sphere iridescent
ERSAV110B-GLIRI	Ø60xH.110 cm	5x E27	15,0 kg	bronze finish, glass sphere iridescent
ERSAV110N-GLIRI	Ø60xH.110 cm	5x E27	15,0 kg	nickel finish, glass sphere iridescent
ERSAV110BR-GLIRI	Ø60xH.110 cm	5x E27	15,0 kg	brass finish, glass sphere iridescent
ERSAV110BRBUR-GLIRI	Ø60xH.110 cm	5x E27	15,0 kg	brass burnished finish, glass sphere iridescent
ERSAV130BLM-GLIRI	Ø90xH.130 cm	8x E27	20,0 kg	black matt finish, glass sphere iridescent
ERSAV130WM-GLIRI	Ø90xH.130 cm	8x E27	20,0 kg	white matt finish, glass sphere iridescent
ERSAV130B-GLIRI	Ø90xH.130 cm	8x E27	20,0 kg	bronze finish, glass sphere iridescent
ERSAV130N-GLIRI	Ø90xH.130 cm	8x E27	20,0 kg	nickel finish, glass sphere iridescent
ERSAV130BR-GLIRI	Ø90xH.130 cm	8x E27	20,0 kg	brass finish, glass sphere iridescent
ERSAV130BRBUR-GLIRI	Ø90xH.130 cm	8x E27	20,0 kg	brass burnished finish, glass sphere iridescent
ERSAV160BLM-GLIRI	Ø90xH.160 cm	9x E27	25,0 kg	black matt finish, glass sphere iridescent
ERSAV160WM-GLIRI	Ø90xH.160 cm	9x E27	25,0 kg	white matt finish, glass sphere iridescent
ERSAV160B-GLIRI	Ø90xH.160 cm	9x E27	25,0 kg	bronze finish, glass sphere iridescent
ERSAV160N-GLIRI	Ø90xH.160 cm	9x E27	25,0 kg	nickel finish, glass sphere iridescent
ERSAV160BR-GLIRI	Ø90xH.160 cm	9x E27	25,0 kg	brass finish, glass sphere iridescent
ERSAV160BRBUR-GLIRI	Ø90xH.160 cm	9x E27	25,0 kg	brass burnished finish, glass sphere iridescent
ERSAV180BLM-GLIRI	Ø90xH.180 cm	9x E27	35,0 kg	black matt finish, glass sphere iridescent
ERSAV180WM-GLIRI	Ø90xH.180 cm	9x E27	35,0 kg	white matt finish, glass sphere iridescent
ERSAV180B-GLIRI	Ø90xH.180 cm	9x E27	35,0 kg	bronze finish, glass sphere iridescent
ERSAV180N-GLIRI	Ø90xH.180 cm	9x E27	35,0 kg	nickel finish, glass sphere iridescent
ERSAV180BR-GLIRI	Ø90xH.180 cm	9x E27	35,0 kg	brass finish, glass sphere iridescent
ERSAV180BRBUR-GLIRI	Ø90xH.180 cm	9x E27	35,0 kg	brass burnished finish, glass sphere iridescent

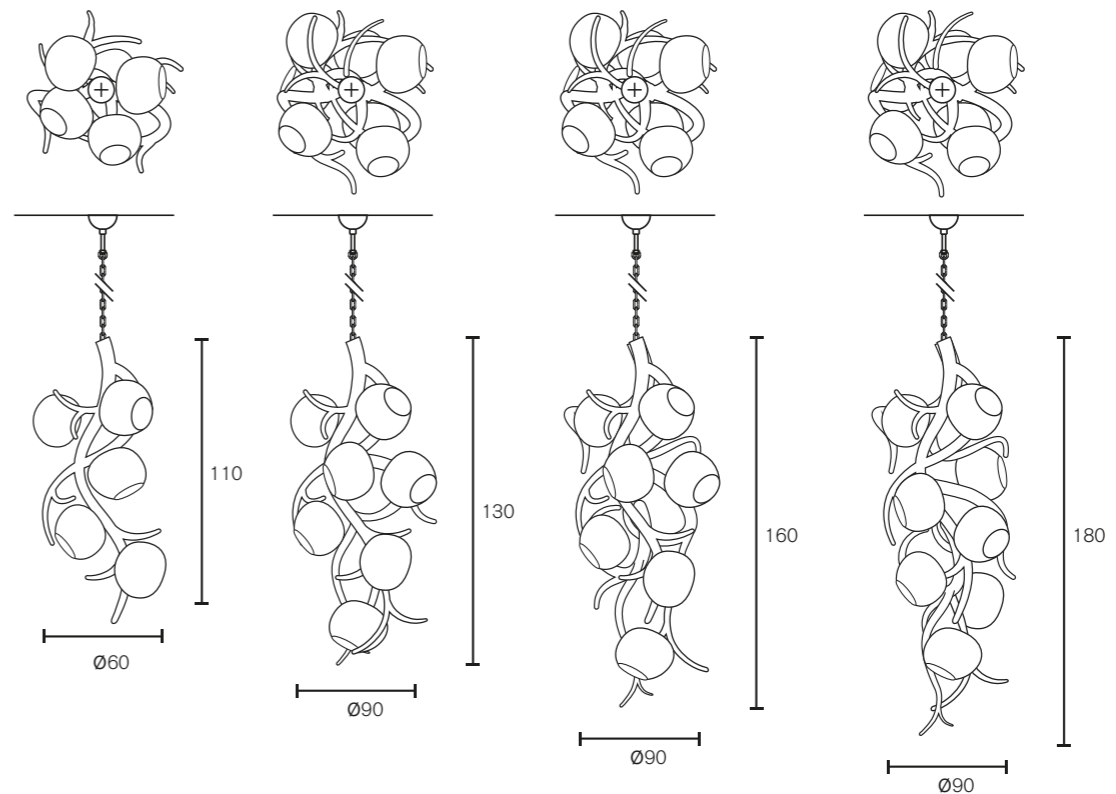

Standard the ERSA will be delivered with iridescent glass spheres. Other options are bronze translucent or clear glass spheres.
All chandeliers are supplied with 1,7 meter chain, 2 meter electrical cable and a ceiling shade.

Technical information

Hanging Lamp Long

Art.nr.	Dimensions	Light bulb	Weight	Finish
ERSAHL150BLM-GLIRI	L.155xW.45xH.35 cm	5x E27	15.0 kg	black matt finish, glass sphere iridescent
ERSAHL150WM-GLIRI	L.155xW.45xH.35 cm	5x E27	15.0 kg	white matt finish, glass sphere iridescent
ERSAHL150B-GLIRI	L.155xW.45xH.35 cm	5x E27	15.0 kg	bronze finish, glass sphere iridescent
ERSAHL150N-GLIRI	L.155xW.45xH.35 cm	5x E27	15.0 kg	nickel finish, glass sphere iridescent
ERSAHL150BR-GLIRI	L.155xW.45xH.35 cm	5x E27	15.0 kg	brass finish, glass sphere iridescent
ERSAHL150BRBUR-GLIRI	L.155xW.45xH.35 cm	5x E27	15.0 kg	brass burnished finish, glass sphere iridescent

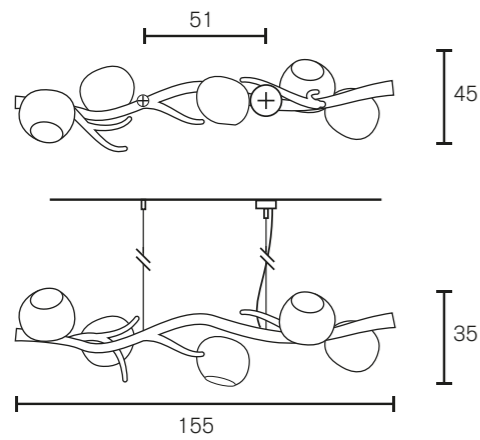

Ceiling Lamp Round

Art.nr.	Dimensions	Light bulb	Weight	Finish
ERSAP60BLM-GLIRI	Ø60xH.25 cm	3x E27	10,0 kg	black matt finish, glass sphere iridescent
ERSAP60WM-GLIRI	Ø60xH.25 cm	3x E27	10,0 kg	white matt finish, glass sphere iridescent
ERSAP60B-GLIRI	Ø60xH.25 cm	3x E27	10,0 kg	bronze finish, glass sphere iridescent
ERSAP60N-GLIRI	Ø60xH.25 cm	3x E27	10,0 kg	nickel finish, glass sphere iridescent
ERSAP60BR-GLIRI	Ø60xH.25 cm	3x E27	10,0 kg	brass finish, glass sphere iridescent
ERSAP60BRBUR-GLIRI	Ø60xH.25 cm	3x E27	10,0 kg	brass burnished finish, glass sphere iridescent

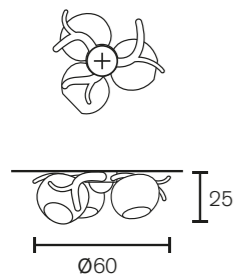

Standard the ERSA will be delivered with iridescent glass spheres. Other options are bronze translucent or clear glass spheres.
All hanging lamps are supplied with 3 meter steel cable, 3 meter electrical cable and a ceiling shade.

Technical information

Ceiling Chandelier

Art.nr.	Dimensions	Light bulb	Weight	Finish
ERSACP80BLM-GLIRI	Ø80xH.65 cm	5x E27	13.0 kg	black matt finish, glass sphere iridescent
ERSACP80WM-GLIRI	Ø80xH.65 cm	5x E27	13.0 kg	white matt finish, glass sphere iridescent
ERSACP80B-GLIRI	Ø80xH.65 cm	5x E27	13.0 kg	bronze finish, glass sphere iridescent
ERSACP80N-GLIRI	Ø80xH.65 cm	5x E27	13.0 kg	nickel finish, glass sphere iridescent
ERSACP80BR-GLIRI	Ø80xH.65 cm	5x E27	13.0 kg	brass finish, glass sphere iridescent
ERSACP80BRBUR-GLIRI	Ø80xH.65 cm	5x E27	13.0 kg	brass burnished finish, glass sphere iridescent

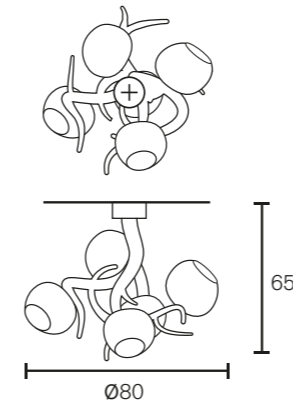

Floor lamp

Art.nr.	Dimensions	Light bulb	Weight	Finish
ERSAF200BLM-GLIRI	Ø40xH.205 cm	3x E27	24.0 kg	black matt finish, glass sphere iridescent
ERSAF200WM-GLIRI	Ø40xH.205 cm	3x E27	24.0 kg	white matt finish, glass sphere iridescent
ERSAF200B-GLIRI	Ø40xH.205 cm	3x E27	24.0 kg	bronze finish, glass sphere iridescent
ERSAF200N-GLIRI	Ø40xH.205 cm	3x E27	24.0 kg	nickel finish, glass sphere iridescent
ERSAF200BR-GLIRI	Ø40xH.205 cm	3x E27	24.0 kg	brass finish, glass sphere iridescent
ERSAF200BRBUR-GLIRI	Ø40xH.205 cm	3x E27	24.0 kg	brass burnished finish, glass sphere iridescent

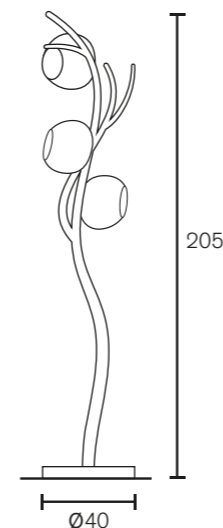

Standard the ERSA will be delivered with iridescent glass spheres. Other options are bronze translucent or clear glass spheres.
All floor lamps are supplied with a floor dimmer.

Technical information

Wall lamp

Art.nr.	Dimensions	Light bulb	Weight	Finish
ERSAW30BLM-GLIRI	W.30xH.45xD.29 cm	1x E27	4,0 kg	black matt finish, glass sphere iridescent
ERSAW30WM-GLIRI	W.30xH.45xD.29 cm	1x E27	4,0 kg	white matt finish, glass sphere iridescent
ERSAW30B-GLIRI	W.30xH.45xD.29 cm	1x E27	4,0 kg	bronze finish, glass sphere iridescent
ERSAW30N-GLIRI	W.30xH.45xD.29 cm	1x E27	4,0 kg	nickel finish, glass sphere iridescent
ERSAW30BR-GLIRI	W.30xH.45xD.29 cm	1x E27	4,0 kg	brass finish, glass sphere iridescent
ERSAW30BRBUR-GLIRI	W.30xH.45xD.29 cm	1x E27	4,0 kg	brass burnished finish, glass sphere iridescent

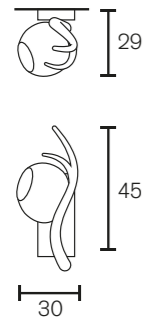

Standard the ERSA will be delivered with iridescent glass spheres. Other options are bronze translucent or clear glass spheres.

Technical information

Element

Art.nr.	Dimensions	Light bulb	Weight	Finish
ERSA1BLM-GLIRI	L.30xH.50x D.30 cm	1x E27	6,0 kg	black matt finish, glass sphere iridescent
ERSA1WM-GLIRI	L.30xH.50x D.30 cm	1x E27	6,0 kg	white matt finish, glass sphere iridescent
ERSA1B-GLIRI	L.30xH.50x D.30 cm	1x E27	6,0 kg	bronze finish, glass sphere iridescent
ERSA1N-GLIRI	L.30xH.50x D.30 cm	1x E27	6,0 kg	nickel finish, glass sphere iridescent
ERSA1BR-GLIRI	L.30xH.50x D.30 cm	1x E27	6,0 kg	brass finish, glass sphere iridescent
ERSA1BRBUR-GLIRI	L.30xH.50x D.30 cm	1x E27	6,0 kg	brass burnished finish, glass sphere iridescent
ERSA2BLM-GLIRI	L.60xH.60x D.55 cm	2x E27	8,0 kg	black matt finish, glass sphere iridescent
ERSA2WM-GLIRI	L.60xH.60x D.55 cm	2x E27	8,0 kg	white matt finish, glass sphere iridescent
ERSA2B-GLIRI	L.60xH.60x D.55 cm	2x E27	8,0 kg	bronze finish, glass sphere iridescent
ERSA2N-GLIRI	L.60xH.60x D.55 cm	2x E27	8,0 kg	nickel finish, glass sphere iridescent
ERSA2BR-GLIRI	L.60xH.60x D.55 cm	2x E27	8,0 kg	brass finish, glass sphere iridescent
ERSA2BRBUR-GLIRI	L.60xH.60x D.55 cm	2x E27	8,0 kg	brass burnished finish, glass sphere iridescent
ERSA3BLM-GLIRI	L.65xH.60x D.55 cm	3x E27	10,0 kg	black matt finish, glass sphere iridescent
ERSA3WM-GLIRI	L.65xH.60x D.55 cm	3x E27	10,0 kg	white matt finish, glass sphere iridescent
ERSA3B-GLIRI	L.65xH.60x D.55 cm	3x E27	10,0 kg	bronze finish, glass sphere iridescent
ERSA3N-GLIRI	L.65xH.60x D.55 cm	3x E27	10,0 kg	nickel finish, glass sphere iridescent
ERSA3BR-GLIRI	L.65xH.60x D.55 cm	3x E27	10,0 kg	brass finish, glass sphere iridescent
ERSA3BRBUR-GLIRI	L.65xH.60x D.55 cm	3x E27	10,0 kg	brass burnished finish, glass sphere iridescent

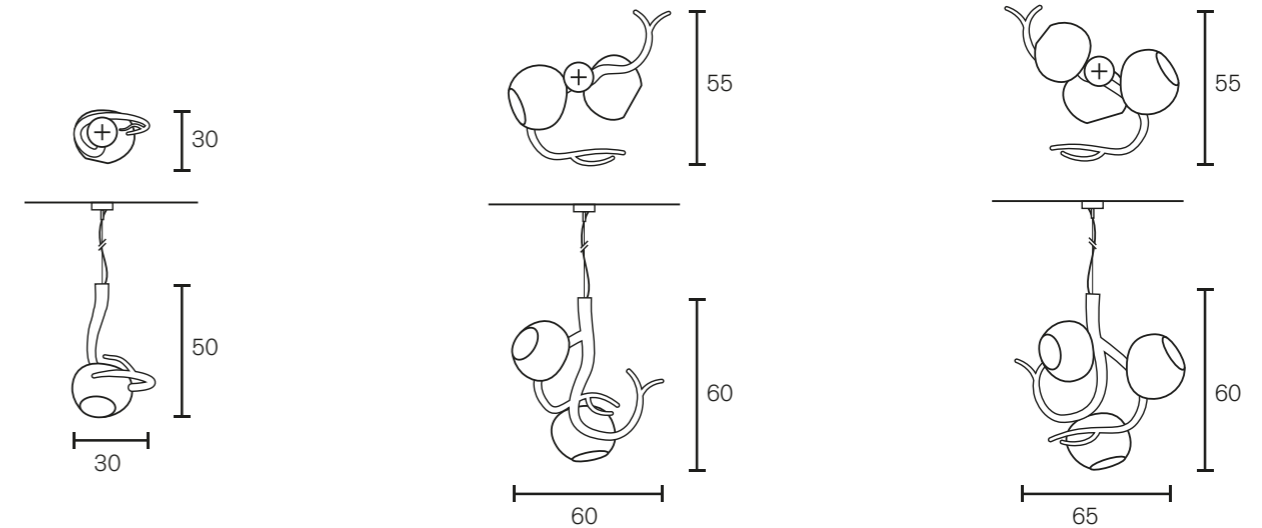

Standard the ERSA will be delivered with iridescent glass spheres. Other options are bronze translucent or clear glass spheres.
All elements are supplied with 3 meter steel cable, 3 meter electrical cable and a ceiling shade.

Technical information

Collection Shiro 2017

Suspension Ring

Art.nr.	Dimensions	Light bulb	Weight	Finish
SHSR100BLM	Ø115xH.33 cm	18x E14	23,0 kg	black matt finish
SHSR100BRBUR	Ø115xH.33 cm	18x E14	23,0 kg	brass burnished finish
SHSR120BLM	Ø135xH.33 cm	20x E14	28,0 kg	black matt finish
SHSR120BRBUR	Ø135xH.33 cm	20x E14	28,0 kg	brass burnished finish
SHSR140BLM	Ø155xH.33 cm	22x E14	35,0 kg	black matt finish
SHSR140BRBUR	Ø155xH.33 cm	22x E14	35,0 kg	brass burnished finish
SHSR160BLM	Ø175xH.33 cm	24x E14	50,0 kg	black matt finish
SHSR160BRBUR	Ø175xH.33 cm	24x E14	50,0 kg	brass burnished finish
SHSR180BLM	Ø195xH.33 cm	26x E14	75,0 kg	black matt finish
SHSR180BRBUR	Ø195xH.33 cm	26x E14	75,0 kg	brass burnished finish
SHSR200BLM	Ø215xH.33 cm	28x E14	100,0 kg	black matt finish
SHSR200BRBUR	Ø215xH.33 cm	28x E14	100,0 kg	brass burnished finish

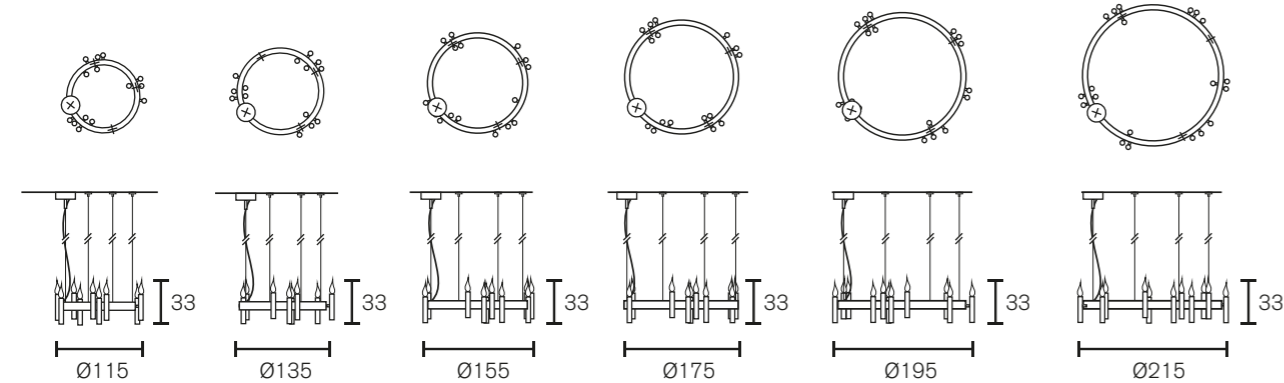

Suspension Horizontal

Art.nr.	Dimensions	Light bulb	Weight	Finish
SHSH100BLM	L.100xW.25xH.33 cm	8x E14	15,0 kg	2x MR11 spot downlight, 12V, black matt finish
SHSH100BRBUR	L.100xW.25xH.33 cm	8x E14	15,0 kg	2x MR11 spot downlight, 12V, brass burnished finish
SHSH120BLM	L.120xW.25xH.33 cm	12x E14	20,0 kg	3x MR11 spot downlight, 12V, black matt finish
SHSH120BRBUR	L.120xW.25xH.33 cm	12x E14	20,0 kg	3x MR11 spot downlight, 12V, brass burnished finish
SHSH150BLM	L.150xW.25xH.33 cm	14x E14	35,0 kg	3x MR11 spot downlight, 12V, black matt finish
SHSH150BRBUR	L.150xW.25xH.33 cm	14x E14	35,0 kg	3x MR11 spot downlight, 12V, brass burnished finish
SHSH200BLM	L.200xW.25xH.33 cm	16x E14	55,0 kg	4x MR11 spot downlight, 12V, black matt finish
SHSH200BRBUR	L.200xW.25xH.33 cm	16x E14	55,0 kg	4x MR11 spot downlight, 12V, brass burnished finish

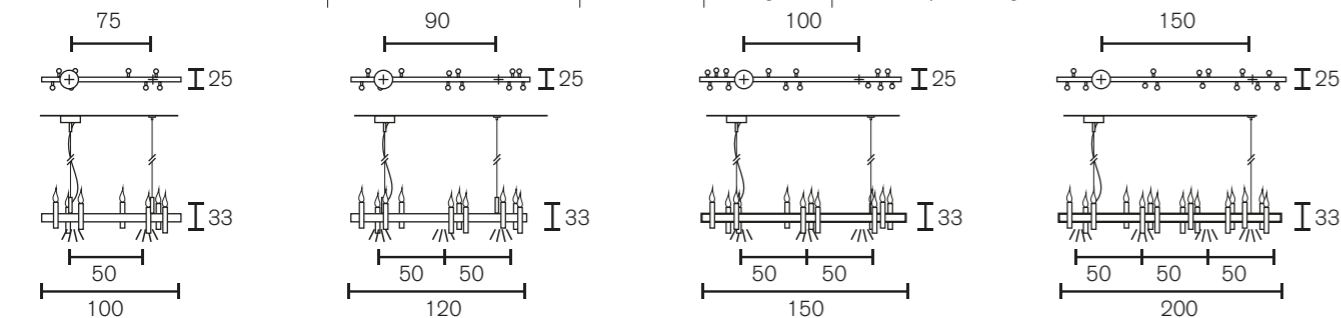

All hanging and suspension lamps are supplied with 3 meter steel cable, 3 meter electric cable and a ceiling shade.
The beam angle for our MR11 spot lights is 36°

Technical information

Suspension Vertical

Art.nr.	Dimensions	Light bulb	Weight	Finish
SHSV70BLM	Ø22xH.80 cm	6x E14	8,0 kg	1x GU10 spot downlight, black matt finish
SHSV70BRBUR	Ø22xH.80 cm	6x E14	8,0 kg	1x GU10 spot downlight, brass burnished finish
SHSV150BLM	Ø22xH.160 cm	9x E14	18,0 kg	1x GU10 spot downlight, black matt finish
SHSV150BRBUR	Ø22xH.160 cm	9x E14	18,0 kg	1x GU10 spot downlight, brass burnished finish
SHSV200BLM	Ø22xH.210 cm	12x E14	30,0 kg	1x GU10 spot downlight, black matt finish
SHSV200BRBUR	Ø22xH.210 cm	12x E14	30,0 kg	1x GU10 spot downlight, brass burnished finish

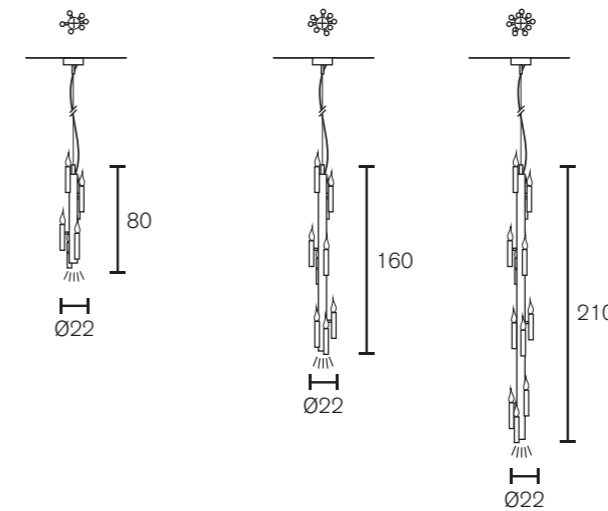

Wall lamp

Art.nr.	Dimensions	Light bulb	Weight	Finish
SHW34BLM	W.12xH.34xD.9 cm	1x E14	2,0 kg	black matt finish
SHW34BRBUR	W.12xH.34xD.9 cm	1x E14	2,0 kg	brass burnished finish

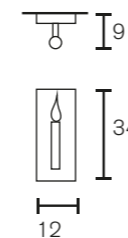

All suspension lamps are supplied with 3 meter steel cable, 3 meter electric cable and a ceiling shade. The beam angle for our GU10 spotlights is 60°

Technical information

Collection EVE 2016

Chandelier Conical

Art.nr.	Dimensions	Light bulb	Weight	Finish
EVECC60BLM	Ø60xH.70 cm	10x E14	14,0 kg	black matt finish
EVECC60WM	Ø60xH.70 cm	10x E14	14,0 kg	white matt finish
EVECC60B	Ø60xH.70 cm	10x E14	14,0 kg	bronze finish
EVECC60N	Ø60xH.70 cm	10x E14	14,0 kg	nickel finish
EVECC60BR	Ø60xH.70 cm	10x E14	14,0 kg	brass finish
EVECC60BRBUR	Ø60xH.70 cm	10x E14	14,0 kg	brass burnished finish
EVECC60NA	Ø60xH.70 cm	10x E14	14,0 kg	nickel aged finish
EVECC70BLM	Ø70xH.80 cm	12x E14	16,0 kg	black matt finish
EVECC70WM	Ø70xH.80 cm	12x E14	16,0 kg	white matt finish
EVECC70B	Ø70xH.80 cm	12x E14	16,0 kg	bronze finish
EVECC70N	Ø70xH.80 cm	12x E14	16,0 kg	nickel finish
EVECC70BR	Ø70xH.80 cm	12x E14	16,0 kg	brass finish
EVECC70BRBUR	Ø70xH.80 cm	12x E14	16,0 kg	brass burnished finish
EVECC70NA	Ø70xH.80 cm	12x E14	16,0 kg	nickel aged finish
EVECC80BLM	Ø80xH.90 cm	12x E14	18,0 kg	black matt finish
EVECC80WM	Ø80xH.90 cm	12x E14	18,0 kg	white matt finish
EVECC80B	Ø80xH.90 cm	12x E14	18,0 kg	bronze finish
EVECC80N	Ø80xH.90 cm	12x E14	18,0 kg	nickel finish
EVECC80BR	Ø80xH.90 cm	12x E14	18,0 kg	brass finish
EVECC80BRBUR	Ø80xH.90 cm	12x E14	18,0 kg	brass burnished finish
EVECC80NA	Ø80xH.90 cm	12x E14	18,0 kg	nickel aged finish

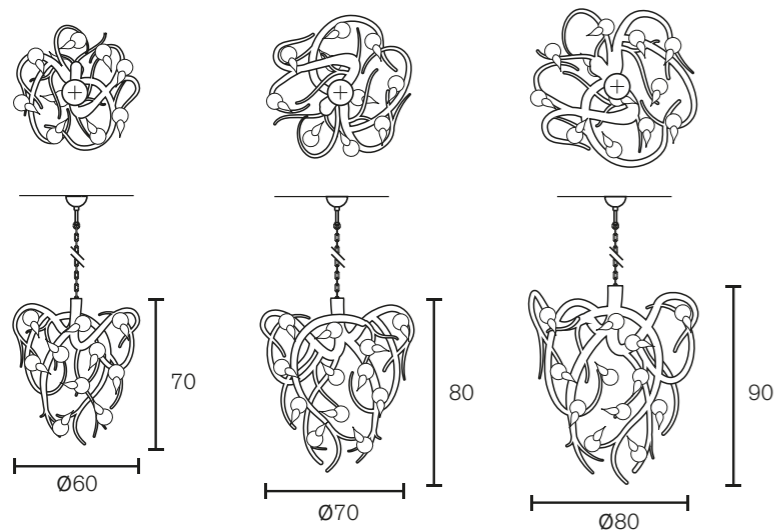

All chandeliers are supplied with 1,7 meter chain, 2 meter electrical cable and a ceiling shade.

Technical information

Chandelier Oval

Art.nr.	Dimensions	Light bulb	Weight	Finish
EVEOC120BLM	L.120xW.60xH.60 cm	10x E14	14,0 kg	black matt finish
EVEOC120WM	L.120xW.60xH.60 cm	10x E14	14,0 kg	white matt finish
EVEOC120B	L.120xW.60xH.60 cm	10x E14	14,0 kg	bronze finish
EVEOC120N	L.120xW.60xH.60 cm	10x E14	14,0 kg	nickel finish
EVEOC120BR	L.120xW.60xH.60 cm	10x E14	14,0 kg	brass finish
EVEOC120BRBUR	L.120xW.60xH.60 cm	10x E14	14,0 kg	brass burnished finish
EVEOC120NA	L.120xW.60xH.60 cm	10x E14	14,0 kg	nickel aged finish
EVEOC140BLM	L.140xW.60xH.60 cm	12x E14	16,0 kg	black matt finish
EVEOC140WM	L.140xW.60xH.60 cm	12x E14	16,0 kg	white matt finish
EVEOC140B	L.140xW.60xH.60 cm	12x E14	16,0 kg	bronze finish
EVEOC140N	L.140xW.60xH.60 cm	12x E14	16,0 kg	nickel finish
EVEOC140BR	L.140xW.60xH.60 cm	12x E14	16,0 kg	brass finish
EVEOC140BRBUR	L.140xW.60xH.60 cm	12x E14	16,0 kg	brass burnished finish
EVEOC140NA	L.140xW.60xH.60 cm	12x E14	16,0 kg	nickel aged finish
EVEOC160BLM	L.160xW.60xH.60 cm	12x E14	18,0 kg	black matt finish
EVEOC160WM	L.160xW.60xH.60 cm	12x E14	18,0 kg	white matt finish
EVEOC160B	L.160xW.60xH.60 cm	12x E14	18,0 kg	bronze finish
EVEOC160N	L.160xW.60xH.60 cm	12x E14	18,0 kg	nickel finish
EVEOC160BR	L.160xW.60xH.60 cm	12x E14	18,0 kg	brass finish
EVEOC160BRBUR	L.160xW.60xH.60 cm	12x E14	18,0 kg	brass burnished finish
EVEOC160NA	L.160xW.60xH.60 cm	12x E14	18,0 kg	nickel aged finish

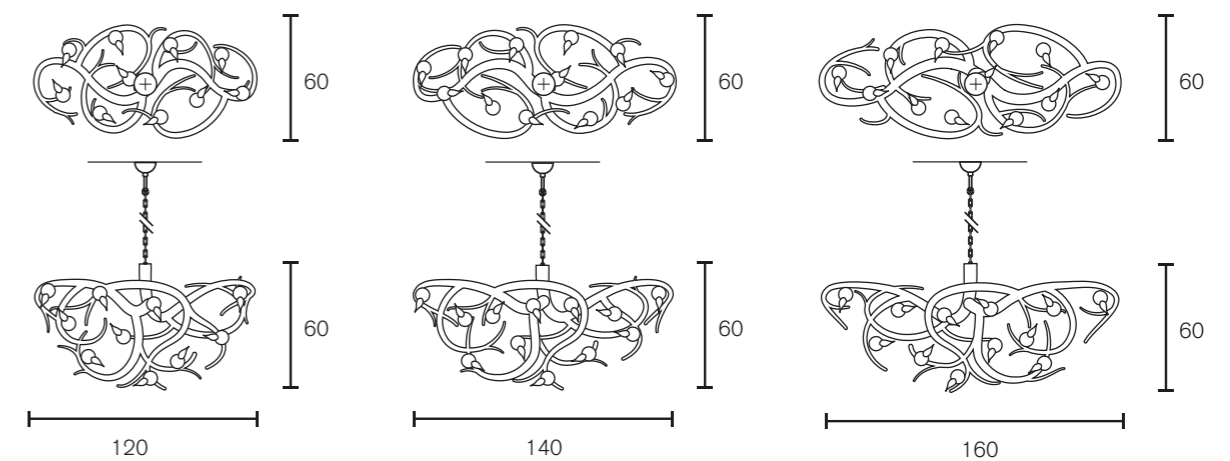

All chandeliers are supplied with 1,7 meter chain, 2 meter electrical cable and a ceiling shade.

Technical information

Chandelier Round

Art.nr.	Dimensions	Light bulb	Weight	Finish
EVEC80BLM	Ø80xH.60 cm	12x E14	11,0 kg	black matt finish
EVEC80WM	Ø80xH.60 cm	12x E14	11,0 kg	white matt finish
EVEC80B	Ø80xH.60 cm	12x E14	11,0 kg	bronze finish
EVEC80N	Ø80xH.60 cm	12x E14	11,0 kg	nickel finish
EVEC80BR	Ø80xH.60 cm	12x E14	11,0 kg	brass finish
EVEC80BRBUR	Ø80xH.60 cm	12x E14	11,0 kg	brass burnished finish
EVEC80NA	Ø80xH.60 cm	12x E14	11,0 kg	nickel aged finish
EVEC100BLM	Ø100xH.60 cm	14x E14	13,0 kg	black matt finish
EVEC100WM	Ø100xH.60 cm	14x E14	13,0 kg	white matt finish
EVEC100B	Ø100xH.60 cm	14x E14	13,0 kg	bronze finish
EVEC100N	Ø100xH.60 cm	14x E14	13,0 kg	nickel finish
EVEC100BR	Ø100xH.60 cm	14x E14	13,0 kg	brass finish
EVEC100BRBUR	Ø100xH.60 cm	14x E14	13,0 kg	brass burnished finish
EVEC100NA	Ø100xH.60 cm	14x E14	13,0 kg	nickel aged finish
EVEC120BLM	Ø120xH.60 cm	16x E14	15,0 kg	black matt finish
EVEC120WM	Ø120xH.60 cm	16x E14	15,0 kg	white matt finish
EVEC120B	Ø120xH.60 cm	16x E14	15,0 kg	bronze finish
EVEC120N	Ø120xH.60 cm	16x E14	15,0 kg	nickel finish
EVEC120BR	Ø120xH.60 cm	16x E14	15,0 kg	brass finish
EVEC120BRBUR	Ø120xH.60 cm	16x E14	15,0 kg	brass burnished finish
EVEC120NA	Ø120xH.60 cm	16x E14	15,0 kg	nickel aged finish

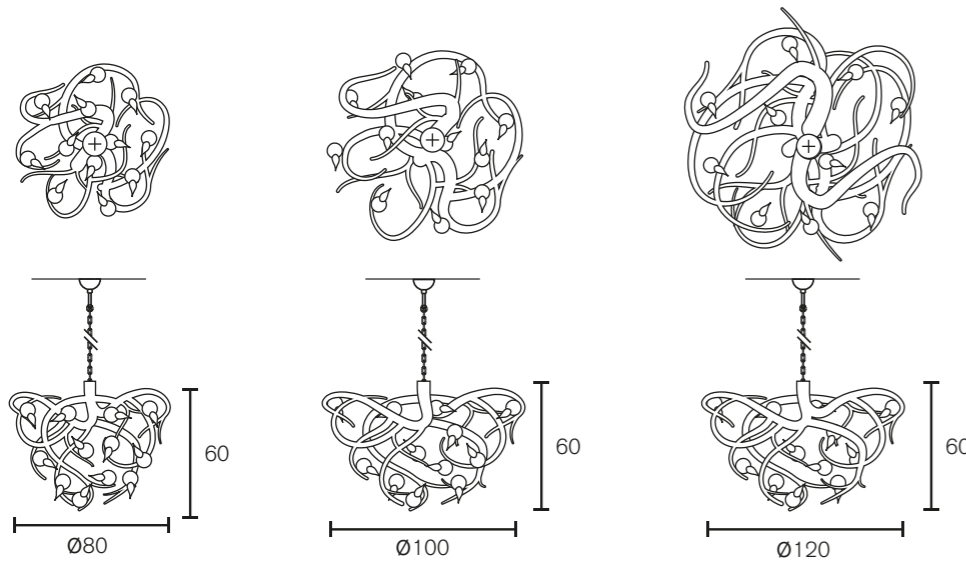

All chandeliers are supplied with 1,7 meter chain, 2 meter electrical cable and a ceiling shade.

Technical information

Collection Fractal 2015

Chandelier Round

Art.nr.	Dimensions	Light bulb	Weight	Finish
FRACC80BLM	Ø80xH.35 cm	10x E14	19,0 kg	black matt finish
FRACC80WM	Ø80xH.35 cm	10x E14	19,0 kg	white matt finish
FRACC80ST	Ø80xH.35 cm	10x E14	19,0 kg	stainless steel
FRACC80BRG	Ø80xH.35 cm	10x E14	19,0 kg	brass grinded finish
FRACC100BLM	Ø100xH.45 cm	12x E14	27,0 kg	black matt finish
FRACC100WM	Ø100xH.45 cm	12x E14	27,0 kg	white matt finish
FRACC100ST	Ø100xH.45 cm	12x E14	27,0 kg	stainless steel
FRACC100BRG	Ø100xH.45 cm	12x E14	27,0 kg	brass grinded finish

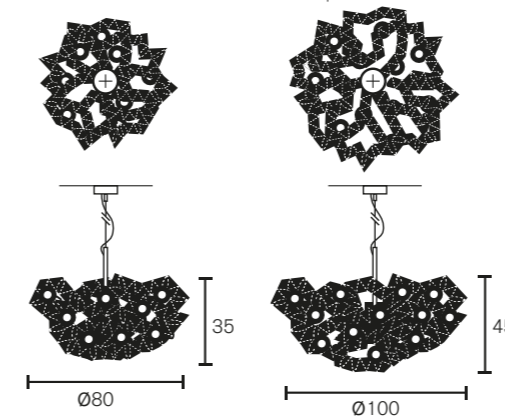

Ceiling Lamp

Art.nr.	Dimensions	Light bulb	Weight	Finish
FRACP60BLM	Ø60xH.30 cm	8x E14	15,0 kg	black matt finish
FRACP60WM	Ø60xH.30 cm	8x E14	15,0 kg	white matt finish
FRACP60ST	Ø60xH.30 cm	8x E14	15,0 kg	stainless steel
FRACP60BRG	Ø60xH.30 cm	8x E14	15,0 kg	brass grinded finish
FRACP80BLM	Ø80xH.35 cm	8x E14	20,0 kg	black matt finish
FRACP80WM	Ø80xH.35 cm	8x E14	20,0 kg	white matt finish
FRACP80ST	Ø80xH.35 cm	8x E14	20,0 kg	stainless steel
FRACP80BRG	Ø80xH.35 cm	8x E14	20,0 kg	brass grinded finish
FRACP100BLM	Ø100xH.35 cm	10x E14	25,0 kg	black matt finish
FRACP100WM	Ø100xH.35 cm	10x E14	25,0 kg	white matt finish
FRACP100ST	Ø100xH.35 cm	10x E14	25,0 kg	stainless steel
FRACP100BRG	Ø100xH.35 cm	10x E14	25,0 kg	brass grinded finish

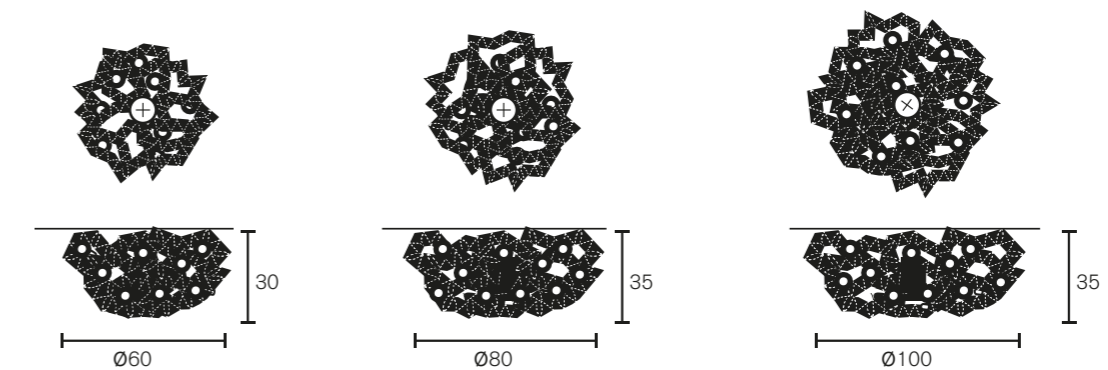

All chandeliers are supplied with 3 meter steel cable, 3 meter electrical cable and a ceiling shade.

Technical information

Collection Fractal Cloud 2015

Hanging Lamp

Art.nr.	Dimensions	Light bulb	Weight	Finish
FRACHR55BLM	Ø55xH.60 cm	3x E27	13,0 kg	black matt finish
FRACHR55WM	Ø55xH.60 cm	3x E27	13,0 kg	white matt finish
FRACHR55ST	Ø55xH.60 cm	3x E27	13,0 kg	stainless steel
FRACHR55BRG	Ø55xH.60 cm	3x E27	13,0 kg	brass grinded finish
FRACHR70BLM	Ø70xH.75 cm	3x E27	18,0 kg	black matt finish
FRACHR70WM	Ø70xH.75 cm	3x E27	18,0 kg	white matt finish
FRACHR70ST	Ø70xH.75 cm	3x E27	18,0 kg	stainless steel
FRACHR70BRG	Ø70xH.75 cm	3x E27	18,0 kg	brass grinded finish

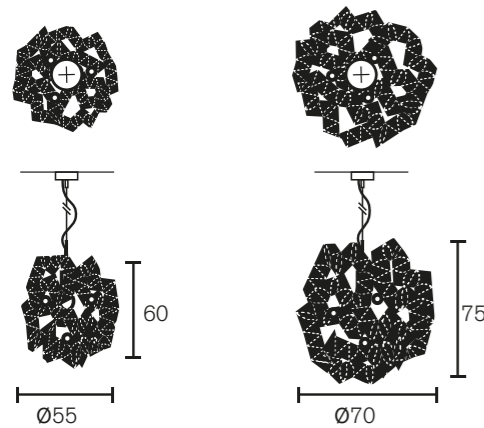

Due to our manual production method, dimensions of Fractal Hanging Lamp Cloud may vary a couple of centimetres in all directions.

All hanging lamps are supplied with 3 meter steel cable, 3 meter electrical cable and a ceiling shade.

Technical information

Collection Flintstone 2015

Floor lamp

Art.nr.	Dimensions	Light bulb	Weight	Finish
FLINTF70BLM	L.70xW.40xH.235 cm	1x E27	40,0 kg	black matt finish
FLINTF70WM	L.70xW.40xH.235 cm	1x E27	40,0 kg	white matt finish
FLINTF70N	L.70xW.40xH.235 cm	1x E27	40,0 kg	nickel finish
FLINTF70BRBUR	L.70xW.40xH.235 cm	1x E27	40,0 kg	brass burnished finish
FLINTF100BLM	L.100xW.40xH.235 cm	1x E27	40,0 kg	black matt finish
FLINTF100WM	L.100xW.40xH.235 cm	1x E27	40,0 kg	white matt finish
FLINTF100N	L.100xW.40xH.235 cm	1x E27	40,0 kg	nickel finish
FLINTF100BRBUR	L.100xW.40xH.235 cm	1x E27	40,0 kg	brass burnished finish
FLINTF130BLM	L.130xW.40xH.235 cm	1x E27	40,0 kg	black matt finish
FLINTF130WM	L.130xW.40xH.235 cm	1x E27	40,0 kg	white matt finish
FLINTF130N	L.130xW.40xH.235 cm	1x E27	40,0 kg	nickel finish
FLINTF130BRBUR	L.130xW.40xH.235 cm	1x E27	40,0 kg	brass burnished finish
FLINTF160BLM	L.160xW.40xH.235 cm	1x E27	40,0 kg	black matt finish
FLINTF160WM	L.160xW.40xH.235 cm	1x E27	40,0 kg	white matt finish
FLINTF160N	L.160xW.40xH.235 cm	1x E27	40,0 kg	nickel finish
FLINTF160BRBUR	L.160xW.40xH.235 cm	1x E27	40,0 kg	brass burnished finish
FLINTF190BLM	L.190xW.40xH.235 cm	1x E27	40,0 kg	black matt finish
FLINTF190WM	L.190xW.40xH.235 cm	1x E27	40,0 kg	white matt finish
FLINTF190N	L.190xW.40xH.235 cm	1x E27	40,0 kg	nickel finish
FLINTF190BRBUR	L.190xW.40xH.235 cm	1x E27	40,0 kg	brass burnished finish
FLINTF210BLM	L.210xW.40xH.235 cm	1x E27	40,0 kg	black matt finish
FLINTF210WM	L.210xW.40xH.235 cm	1x E27	40,0 kg	white matt finish
FLINTF210N	L.210xW.40xH.235 cm	1x E27	40,0 kg	nickel finish
FLINTF210BRBUR	L.210xW.40xH.235 cm	1x E27	40,0 kg	brass burnished finish
FLINTF240BLM	L.240xW.40xH.235 cm	1x E27	40,0 kg	black matt finish
FLINTF240WM	L.240xW.40xH.235 cm	1x E27	40,0 kg	white matt finish
FLINTF240N	L.240xW.40xH.235 cm	1x E27	40,0 kg	nickel finish
FLINTF240BRBUR	L.240xW.40xH.235 cm	1x E27	40,0 kg	brass burnished finish

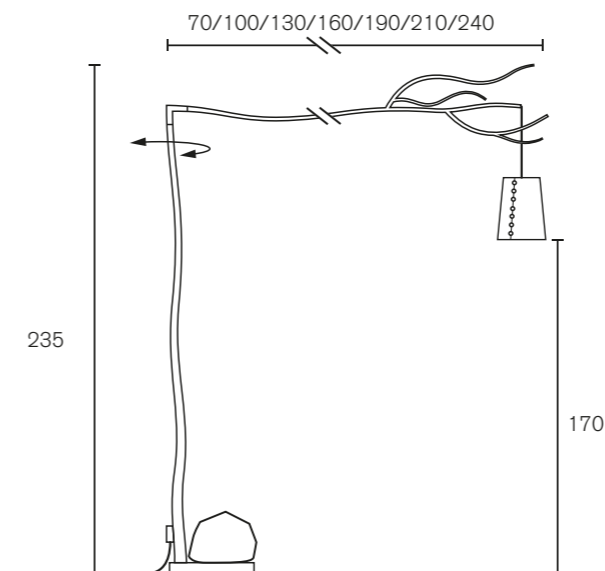

Lamp shade can be in the same colour as the floor lamp without upcharge.
A unique rock will be included with each Flintstone by Brand van Egmond
All floor lamps are supplied with a floor dimmer.

Technical information

Collection Kelp 2014

Chandelier Conical

Art.nr.	Dimensions	Light bulb	Weight	Finish
KELPCC60BLM	Ø60xH.70 cm	10x E14	25,0 kg	black matt finish
KELPCC60ST	Ø60xH.70 cm	10x E14	25,0 kg	stainless steel
KELPCC60BR	Ø60xH.70 cm	10x E14	25,0 kg	brass finish
KELPCC60BRA	Ø60xH.70 cm	10x E14	25,0 kg	brass aged finish
KELPCC60BRG	Ø60xH.70 cm	10x E14	25,0 kg	brass grinded finish
KELPCC60BRBUR	Ø60xH.70 cm	10x E14	25,0 kg	brass burnished finish
KELPCC60COP	Ø60xH.70 cm	10x E14	25,0 kg	copper finish
KELPCC80BLM	Ø80xH.90 cm	10x E14	30,0 kg	black matt finish
KELPCC80ST	Ø80xH.90 cm	10x E14	30,0 kg	stainless steel
KELPCC80BR	Ø80xH.90 cm	10x E14	30,0 kg	brass finish
KELPCC80BRA	Ø80xH.90 cm	10x E14	30,0 kg	brass aged finish
KELPCC80BRG	Ø80xH.90 cm	10x E14	30,0 kg	brass grinded finish
KELPCC80BRBUR	Ø80xH.90 cm	10x E14	30,0 kg	brass burnished finish
KELPCC80COP	Ø80xH.90 cm	10x E14	30,0 kg	copper finish

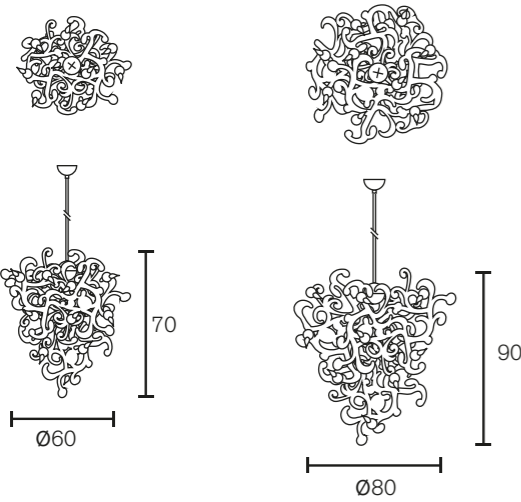

All chandeliers are supplied with 2 meter stem and a ceiling shade.

Technical information

Chandelier Oval

Art.nr.	Dimensions	Light bulb	Weight	Finish
KELPOC120BLM	L.120xW.60xH.55 cm	10x E14	25,0 kg	black matt finish
KELPOC120ST	L.120xW.60xH.55 cm	10x E14	25,0 kg	stainless steel
KELPOC120BR	L.120xW.60xH.55 cm	10x E14	25,0 kg	brass finish
KELPOC120BRA	L.120xW.60xH.55 cm	10x E14	25,0 kg	brass aged finish
KELPOC120BRG	L.120xW.60xH.55 cm	10x E14	25,0 kg	brass grinded finish
KELPOC120BRBUR	L.120xW.60xH.55 cm	10x E14	25,0 kg	brass burnished finish
KELPOC120COP	L.120xW.60xH.55 cm	10x E14	25,0 kg	copper finish
KELPOC140BLM	L.140xW.60xH.55 cm	10x E14	30,0 kg	black matt finish
KELPOC140ST	L.140xW.60xH.55 cm	10x E14	30,0 kg	stainless steel
KELPOC140BR	L.140xW.60xH.55 cm	10x E14	30,0 kg	brass finish
KELPOC140BRA	L.140xW.60xH.55 cm	10x E14	30,0 kg	brass aged finish
KELPOC140BRG	L.140xW.60xH.55 cm	10x E14	30,0 kg	brass grinded finish
KELPOC140BRBUR	L.140xW.60xH.55 cm	10x E14	30,0 kg	brass burnished finish
KELPOC140COP	L.140xW.60xH.55 cm	10x E14	30,0 kg	copper finish
KELPOC160BLM	L.160xW.60xH.55 cm	10x E14	40,0 kg	black matt finish
KELPOC160ST	L.160xW.60xH.55 cm	10x E14	40,0 kg	stainless steel
KELPOC160BR	L.160xW.60xH.55 cm	10x E14	40,0 kg	brass finish
KELPOC160BRA	L.160xW.60xH.55 cm	10x E14	40,0 kg	brass aged finish
KELPOC160BRG	L.160xW.60xH.55 cm	10x E14	40,0 kg	brass grinded finish
KELPOC160BRBUR	L.160xW.60xH.55 cm	10x E14	40,0 kg	brass burnished finish
KELPOC160COP	L.160xW.60xH.55 cm	10x E14	40,0 kg	copper finish

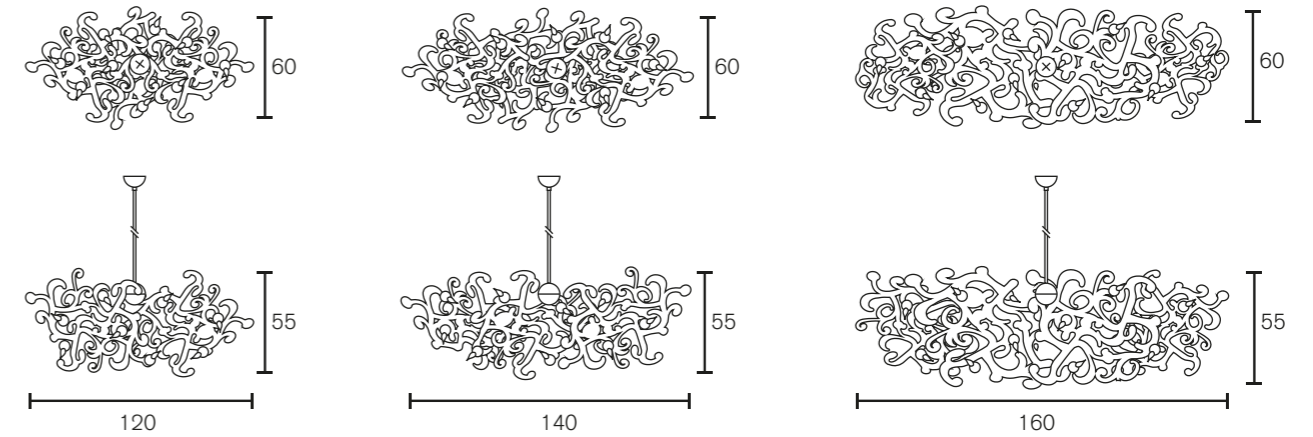

All chandeliers are supplied with 2 meter stem and a ceiling shade.

Technical information

Chandelier Round

Art.nr.	Dimensions	Light bulb	Weight	Finish
KELPC80BLM	Ø80xH.60 cm	10x E14	25,0 kg	black matt finish
KELPC80ST	Ø80xH.60 cm	10x E14	25,0 kg	stainless steel
KELPC80BR	Ø80xH.60 cm	10x E14	25,0 kg	brass finish
KELPC80BRA	Ø80xH.60 cm	10x E14	25,0 kg	brass aged finish
KELPC80BRG	Ø80xH.60 cm	10x E14	25,0 kg	brass grinded finish
KELPC80BRBUR	Ø80xH.60 cm	10x E14	25,0 kg	brass burnished finish
KELPC80COP	Ø80xH.60 cm	10x E14	25,0 kg	copper finish
KELPC100BLM	Ø100xH.60 cm	10x E14	30,0 kg	black matt finish
KELPC100ST	Ø100xH.60 cm	10x E14	30,0 kg	stainless steel
KELPC100BR	Ø100xH.60 cm	10x E14	30,0 kg	brass finish
KELPC100BRA	Ø100xH.60 cm	10x E14	30,0 kg	brass aged finish
KELPC100BRG	Ø100xH.60 cm	10x E14	30,0 kg	brass grinded finish
KELPC100BRBUR	Ø100xH.60 cm	10x E14	30,0 kg	brass burnished finish
KELPC100COP	Ø100xH.60 cm	10x E14	30,0 kg	copper finish
KELPC120BLM	Ø120xH.60 cm	10x E14	40,0 kg	black matt finish
KELPC120ST	Ø120xH.60 cm	10x E14	40,0 kg	stainless steel
KELPC120BR	Ø120xH.60 cm	10x E14	40,0 kg	brass finish
KELPC120BRA	Ø120xH.60 cm	10x E14	40,0 kg	brass aged finish
KELPC120BRG	Ø120xH.60 cm	10x E14	40,0 kg	brass grinded finish
KELPC120BRBUR	Ø120xH.60 cm	10x E14	40,0 kg	brass burnished finish
KELPC120COP	Ø120xH.60 cm	10x E14	40,0 kg	copper finish

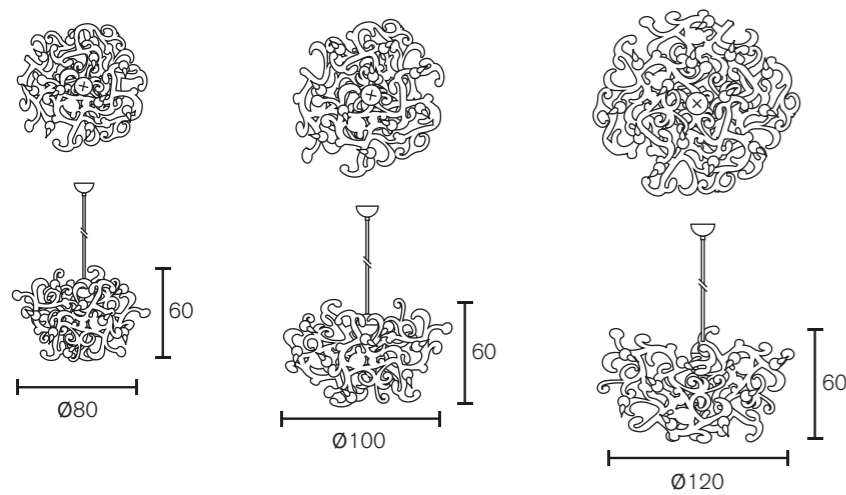

All chandeliers are supplied with 2 meter stem and a ceiling shade.

Technical information

Ceiling Lamp Round

Art.nr.	Dimensions	Light bulb	Weight	Finish
KELPP60BLM	Ø60xH.30 cm	6x E14	13,0 kg	black matt finish
KELPP60ST	Ø60xH.30 cm	6x E14	13,0 kg	stainless steel
KELPP60BR	Ø60xH.30 cm	6x E14	13,0 kg	brass finish
KELPP60BRA	Ø60xH.30 cm	6x E14	13,0 kg	brass aged finish
KELPP60BRG	Ø60xH.30 cm	6x E14	13,0 kg	brass grinded finish
KELPP60BRBUR	Ø60xH.30 cm	6x E14	13,0 kg	brass burnished finish
KELPP60COP	Ø60xH.30 cm	6x E14	13,0 kg	copper finish
KELPP80BLM	Ø80xH.30 cm	6x E14	15,0 kg	black matt finish
KELPP80ST	Ø80xH.30 cm	6x E14	15,0 kg	stainless steel
KELPP80BR	Ø80xH.30 cm	6x E14	15,0 kg	brass finish
KELPP80BRA	Ø80xH.30 cm	6x E14	15,0 kg	brass aged finish
KELPP80BRG	Ø80xH.30 cm	6x E14	15,0 kg	brass grinded finish
KELPP80BRBUR	Ø80xH.30 cm	6x E14	15,0 kg	brass burnished finish
KELPP80COP	Ø80xH.30 cm	6x E14	15,0 kg	copper finish

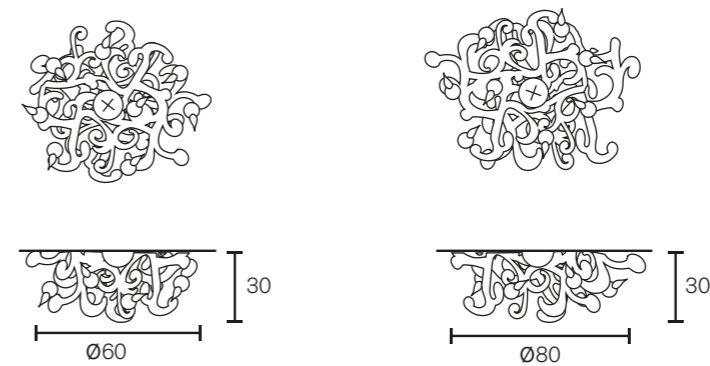

Technical information

Collection Kelp 2015

Element

Art.nr.	Dimensions	Light bulb	Weight	Finish
25KELPBLM	L.25xW.25xH.35 cm	1x E14	1,5 kg	black matt finish
25KELPST	L.25xW.25xH.35 cm	1x E14	1,5 kg	stainless steel
25KELPBR	L.25xW.25xH.35 cm	1x E14	1,5 kg	brass finish
25KELPBRA	L.25xW.25xH.35 cm	1x E14	1,5 kg	brass aged finish
25KELPBRG	L.25xW.25xH.35 cm	1x E14	1,5 kg	brass grinded finish
25KELPBRBUR	L.25xW.25xH.35 cm	1x E14	1,5 kg	brass burnished finish
25KELPCOP	L.25xW.25xH.35 cm	1x E14	1,5 kg	copper finish
50KELPBLM	L.40xW.40xH.50 cm	1x E14	2,0 kg	black matt finish
50KELPST	L.40xW.40xH.50 cm	1x E14	2,0 kg	stainless steel
50KELPBR	L.40xW.40xH.50 cm	1x E14	2,0 kg	brass finish
50KELPBRA	L.40xW.40xH.50 cm	1x E14	2,0 kg	brass aged finish
50KELPBRG	L.40xW.40xH.50 cm	1x E14	2,0 kg	brass grinded finish
50KELPBRBUR	L.40xW.40xH.50 cm	1x E14	2,0 kg	brass burnished finish
50KELPCOP	L.40xW.40xH.50 cm	1x E14	2,0 kg	copper finish
100KELPBLM	L.80xW.100xH.80 cm	5x E14	15,0 kg	black matt finish
100KELPST	L.80xW.100xH.80 cm	5x E14	15,0 kg	stainless steel
100KELPBR	L.80xW.100xH.80 cm	5x E14	15,0 kg	brass finish
100KELPBRA	L.80xW.100xH.80 cm	5x E14	15,0 kg	brass aged finish
100KELPBRG	L.80xW.100xH.80 cm	5x E14	15,0 kg	brass grinded finish
100KELPBRBUR	L.80xW.100xH.80 cm	5x E14	15,0 kg	brass burnished finish
100KELPCOP	L.80xW.100xH.80 cm	5x E14	15,0 kg	copper finish

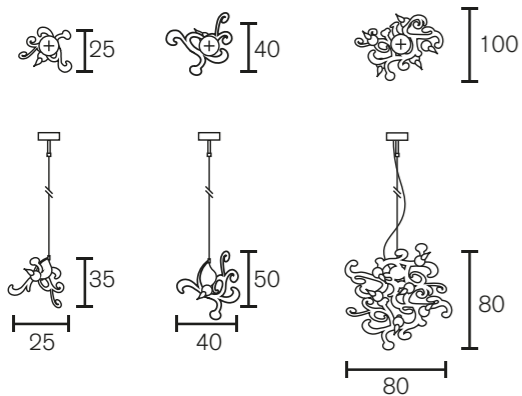

Kelp elements are supplied with 3 meter steel cable, 3 meter electrical cable and a ceiling shade
 25Kelp and 50Kelp elements are supplied with 3 meter electrical cable and a ceiling shade.
 25Kelp and 50Kelp elements are hanging on an electrical cable

Technical information

Suspension options

Central Ceiling Pot

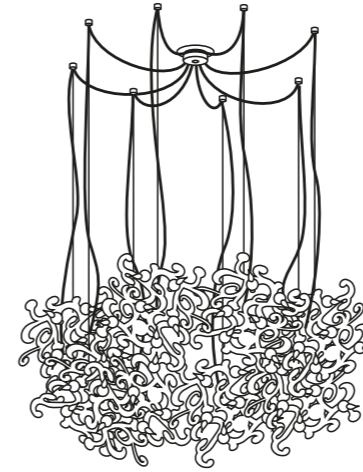

Ceiling Spider



Ceiling Disc



Ceiling Beam

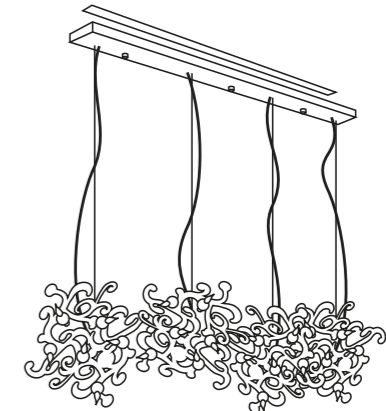

Technical information

Collection Arthur 2014

Chandelier Conical

Art.nr.	Dimensions	Light bulb	Weight	Finish
ARCC60N	Ø60xH.70 cm	10x E14	30,0 kg	nickel finish
ARCC70N	Ø70xH.80 cm	12x E14	35,0 kg	nickel finish
ARCC80N	Ø80xH.100 cm	14x E14	40,0 kg	nickel finish

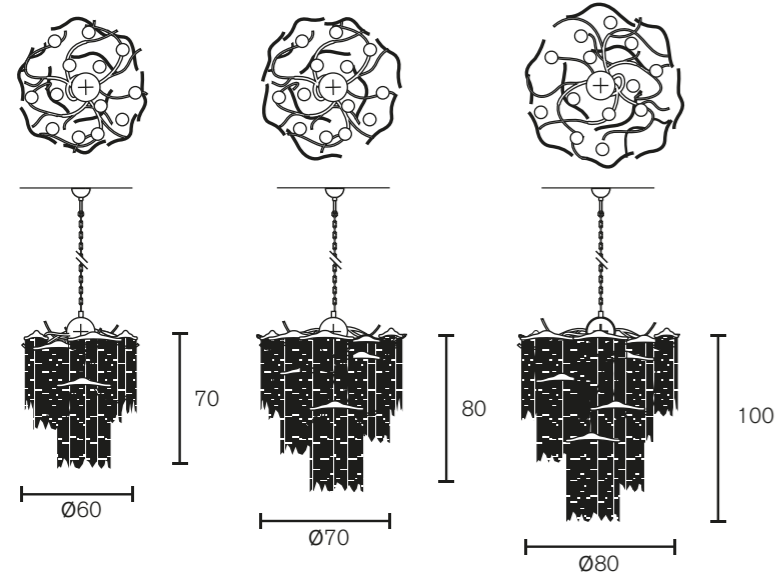

Chandelier Oval

Art.nr.	Dimensions	Light bulb	Weight	Finish
AROC120N	L.120xW.60xH.55 cm	12x E14	35,0 kg	nickel finish
AROC140N	L.140xW.60xH.55 cm	12x E14	36,0 kg	nickel finish
AROC160N	L.160xW.60xH.55 cm	16x E14	45,0 kg	nickel finish
AROC180N	L.180xW.60xH.55 cm	16x E14	47,0 kg	nickel finish

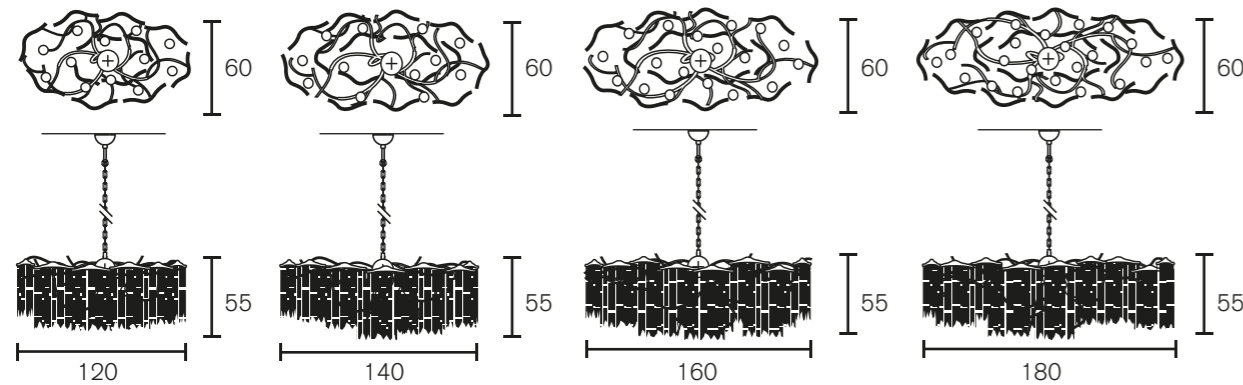

All chandeliers are supplied with 1,7 meter chain, 2 meter electrical cable and a ceiling shade.

Technical information

Chandelier Round

Art.nr.	Dimensions	Light bulb	Weight	Finish
ARC80N	Ø80xH.50 cm	12x E14	30,0 kg	nickel finish
ARC100N	Ø100xH.55 cm	14x E14	40,0 kg	nickel finish
ARC120N	Ø120xH.70 cm	16x E14	60,0 kg	nickel finish

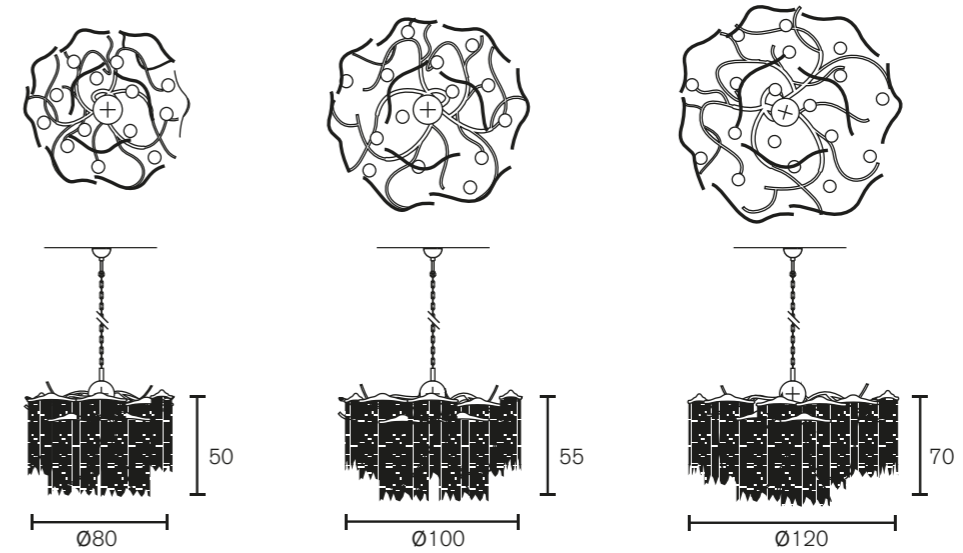

Hanging Lamp

Art.nr.	Dimensions	Light bulb	Weight	Finish
AR18N	Ø18xH.75 cm	3x E14	10,0 kg	nickel finish

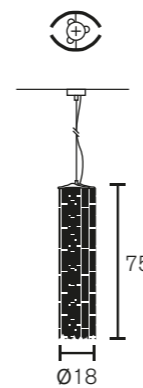

All chandeliers are supplied with 1,7 meter chain, 2 meter electrical cable and a ceiling shade. All hanging lamps are supplied with 3 meter steel cable, 3 meter electrical cable and a ceiling shade

Technical information

Ceiling Lamp Round

Art.nr.	Dimensions	Light bulb	Weight	Finish
ARP60N	Ø60xH.45 cm	4x E14	25,0 kg	nickel finish
ARP80N	Ø80xH.45 cm	6x E14	27,0 kg	nickel finish

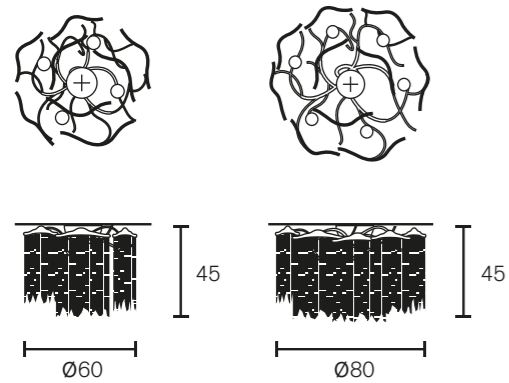

Floor Lamp

Art.nr.	Dimensions	Light bulb	Weight	Finish
ARF190N	Ø30xH.190 cm	5x E14	32,0 kg	nickel finish

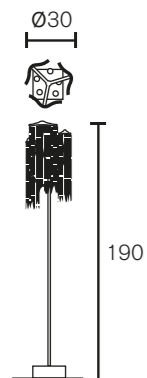
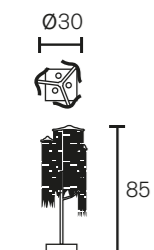

Table Lamp

Art.nr.	Dimensions	Light bulb	Weight	Finish
ART30N	Ø30xH.85 cm	3x E14	17,0 kg	nickel finish



All floor- and table lamps are supplied with a dimmer.

Technical information

Wall Lamp

Art.nr.	Dimensions	Light bulb	Weight	Finish
ARW50N	W.20xH.50xD.12 cm	1x E14	7,0 kg	nickel finish
ARW70N	W.30xH.70xD.12 cm	2x E14	10,0 kg	nickel finish

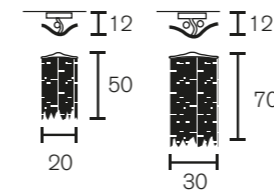

Technical information

Collection Victoria 2014

Chandelier Conical

Art.nr.	Dimensions	Light bulb	Weight	Finish
VCC60N	Ø60xH.70 cm	8x E14	24,0 kg	nickel finish
VCC70N	Ø70xH.80 cm	12x E14	28,0 kg	nickel finish
VCC80N	Ø80xH.100 cm	14x E14	30,0 kg	nickel finish

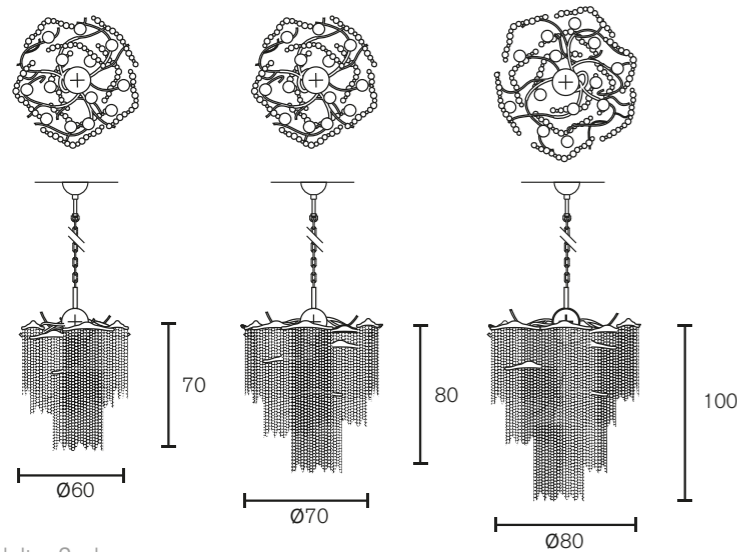

Chandelier Oval

Art.nr.	Dimensions	Light bulb	Weight	Finish
VOC120N	L.120xW.60xH.55 cm	12x E14	22,0 kg	nickel finish
VOC140N	L.140xW.60xH.55 cm	12x E14	26,0 kg	nickel finish
VOC160N	L.160xW.60xH.55 cm	16x E14	30,0 kg	nickel finish
VOC180N	L.180xW.60xH.55 cm	16x E14	36,0 kg	nickel finish

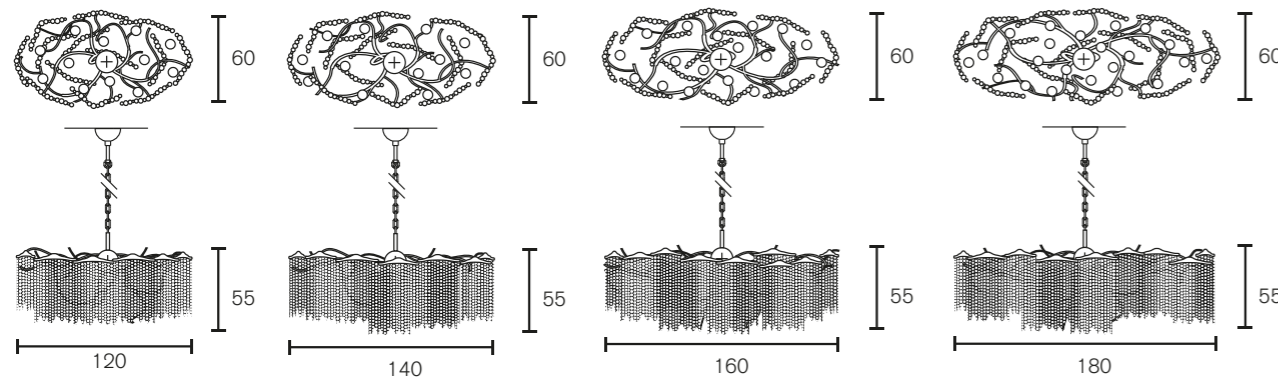

All chandeliers are supplied with 1,7 meter chain, 2 meter electrical cable and a ceiling shade.

Technical information

Chandelier Round

Art.nr.	Dimensions	Light bulb	Weight	Finish
VC80N	Ø80xH.50 cm	12x E14	25,0 kg	nickel finish
VC100N	Ø100xH.55 cm	14x E14	29,0 kg	nickel finish
VC120N	Ø120xH.70 cm	16x E14	32,0 kg	nickel finish

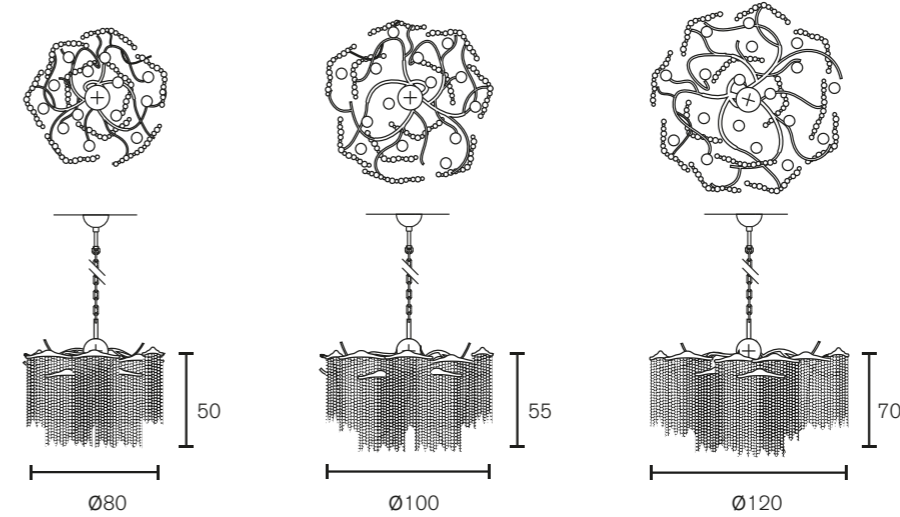

Hanging Lamp

Art.nr.	Dimensions	Light bulb	Weight	Finish
VC18N	Ø18xH.75 cm	3x E14	7,0 kg	nickel finish

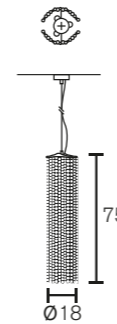

Ceiling Lamp Round

Art.nr.	Dimensions	Light bulb	Weight	Finish
VP60N	Ø60xH.45 cm	4x E14	13,0 kg	nickel finish
VP80N	Ø80xH.45 cm	6x E14	20,0 kg	nickel finish

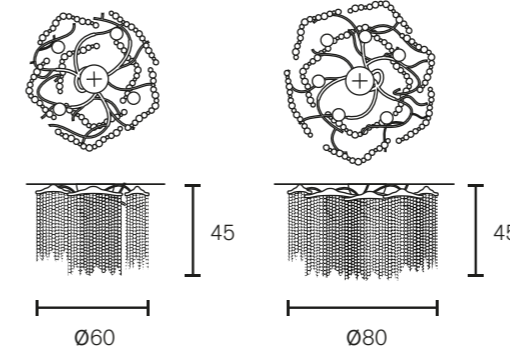

All chandeliers are supplied with 1,7 meter chain, 2 meter electrical cable and a ceiling shade. All hanging lamps are supplied with 3 meter steel cable, 3 meter electrical cable and a ceiling shade.

Technical information

Floor Lamp

Art.nr.	Dimensions	Light bulb	Weight	Finish
VF190N	Ø30xH.190 cm	5x E14	27,0 kg	nickel finish

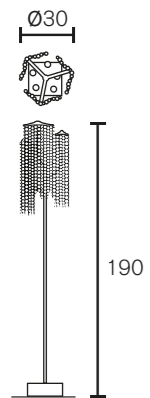
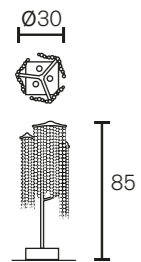

Table Lamp

Art.nr.	Dimensions	Light bulb	Weight	Finish
VT30N	Ø30xH.85 cm	3x E14	12,0 kg	nickel finish



Wall Lamp

Art.nr.	Dimensions	Light bulb	Weight	Finish
VW50N	W.20xH.50xD.12 cm	1x E14	5,0 kg	nickel finish
VW70N	W.30xH.70xD.12 cm	2x E14	8,0 kg	nickel finish

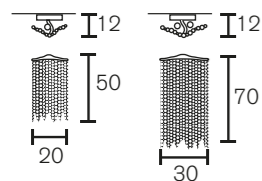

All floor and table lamps are supplied with a dimmer.

Technical information

Collection Sultans of Swing 2012

Chandelier Conical

Art.nr.	Dimensions	Light bulb	Weight	Finish
SOSCC60N	Ø60xH.80 cm	12x E14	23,0 kg	nickel finish
SOSCC80N	Ø80xH.100 cm	14x E14	30,0 kg	nickel finish
SOSCC100N	Ø100xH.120 cm	16x E14	37,0 kg	nickel finish

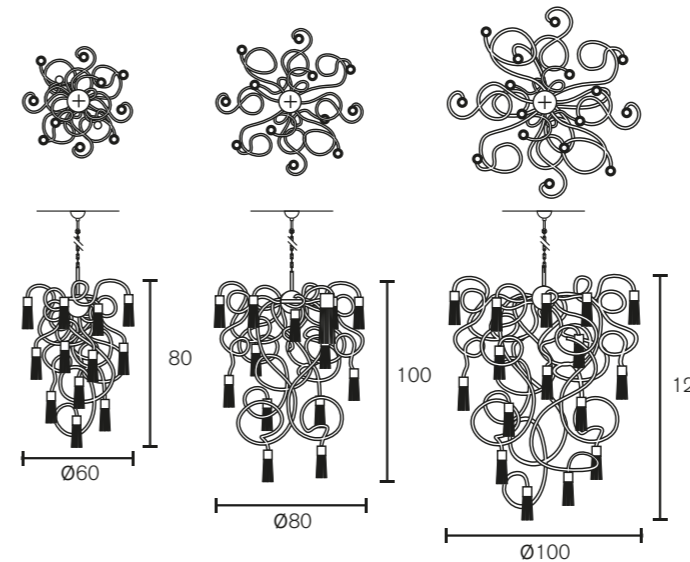

Chandelier Oval

Art.nr.	Dimensions	Light bulb	Weight	Finish
SOSOC120N	L.120xW.60xH.55 cm	14x E14	21,0 kg	nickel finish
SOSOC140N	L.140xW.70xH.55 cm	14x E14	26,0 kg	nickel finish
SOSOC160N	L.160xW.70xH.55 cm	14x E14	35,0 kg	nickel finish

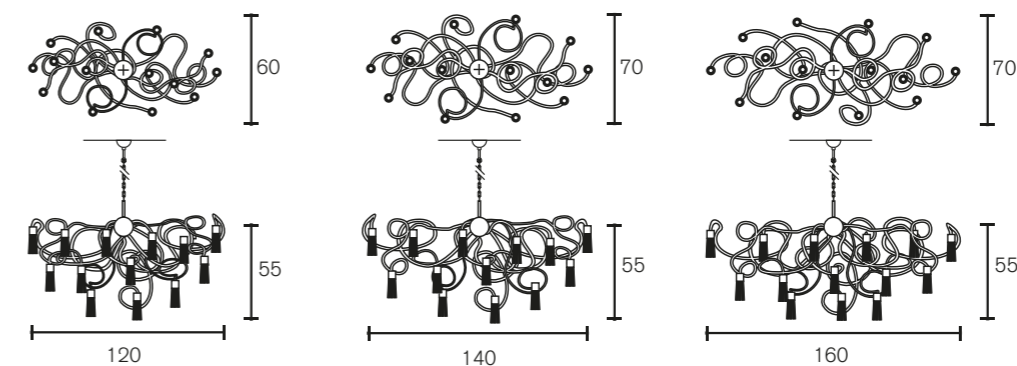

All chandeliers are supplied with 1,7 meter chain, 2 meter electrical cable and a ceiling shade.

Technical information

Chandelier Round

Art.nr.	Dimensions	Light bulb	Weight	Finish
SOSC60N	Ø60xH.50 cm	8x E14	23,0 kg	nickel finish
SOSC80N	Ø80xH.55 cm	12x E14	30,0 kg	nickel finish
SOSC100N	Ø100xH.60 cm	14x E14	38,0 kg	nickel finish

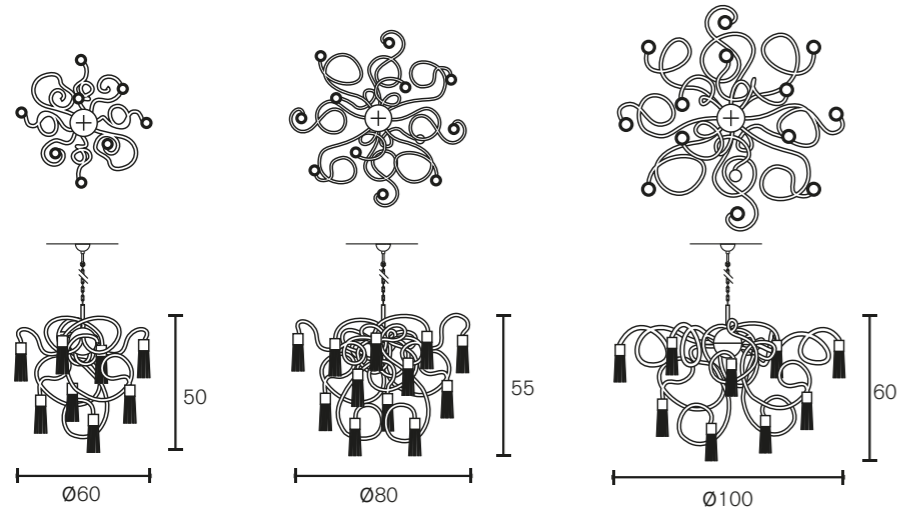

Hanging Lamp

Art.nr.	Dimensions	Light bulb	Weight	Finish
SOSH120N	L.120xW.40xH.45 cm	6x E14	10,0 kg	nickel finish
SOSH140N	L.140xW.40xH.45 cm	6x E14	15,0 kg	nickel finish
SOSH160N	L.160xW.40xH.45 cm	8x E14	20,0 kg	nickel finish

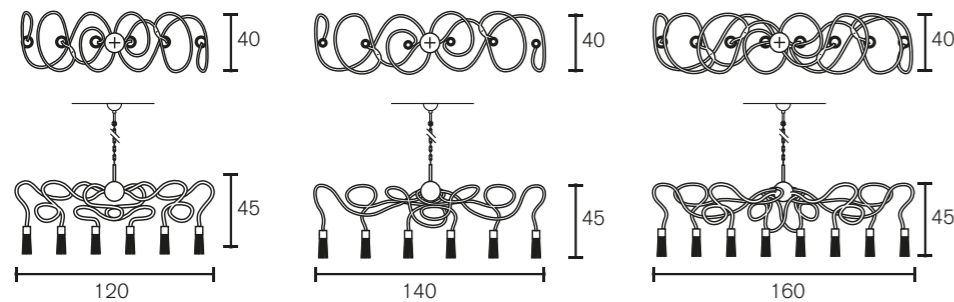

All chandeliers are supplied with 1,7 meter chain, 2 meter electrical cable and a ceiling shade.

Technical information

Ceiling Lamp Round

Art.nr.	Dimensions	Light bulb	Weight	Finish
SOSP60N	Ø60xH.35 cm	6x E14	10,0 kg	nickel finish
SOSP80N	Ø80xH.35 cm	8x E14	13,0 kg	nickel finish
SOSP100N	Ø100xH.35 cm	8x E14	18,0 kg	nickel finish

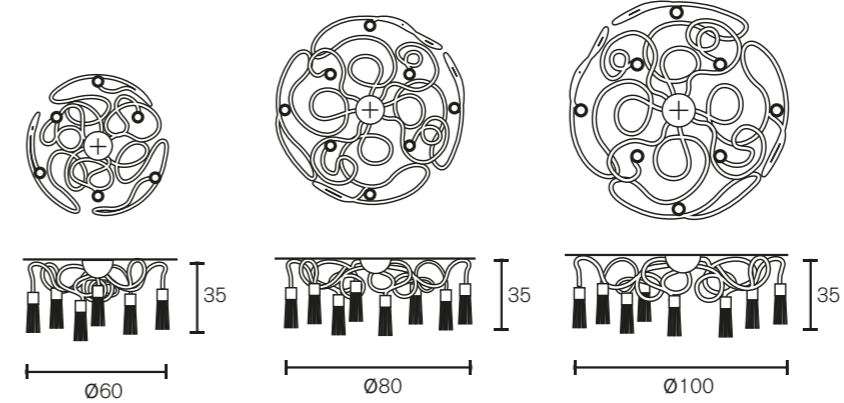
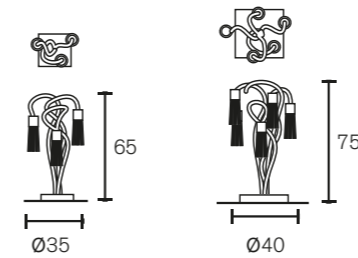

Table Lamp

Art.nr.	Dimensions	Light bulb	Weight	Finish
SOST65N	Ø35xH.65 cm	3x E14	10,0 kg	nickel finish
SOST75N	Ø40xH.75 cm	5x E14	12,0 kg	nickel finish



Wall Lamp

Art.nr.	Dimensions	Light bulb	Weight	Finish
SOSW36N	W.12xH.36xD.12 cm	1x E14	3,5 kg	nickel finish
SOSW40N	W.25xH.40xD.12 cm	2x E14	5,0 kg	nickel finish
SOSW50N	W.25xH.50xD.12 cm	3x E14	11,0 kg	nickel finish
SOSW65N	W.30xH.65xD.12 cm	4x E14	14,0 kg	nickel finish

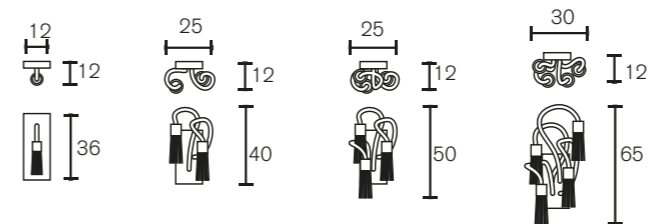

All table lamps are supplied with a table dimmer.

Technical information

Element

Art.nr.	Dimensions	Light bulb	Weight	Finish
55SOSST	Ø15xH.55 cm	1x E14	2,0 kg	stainless steel

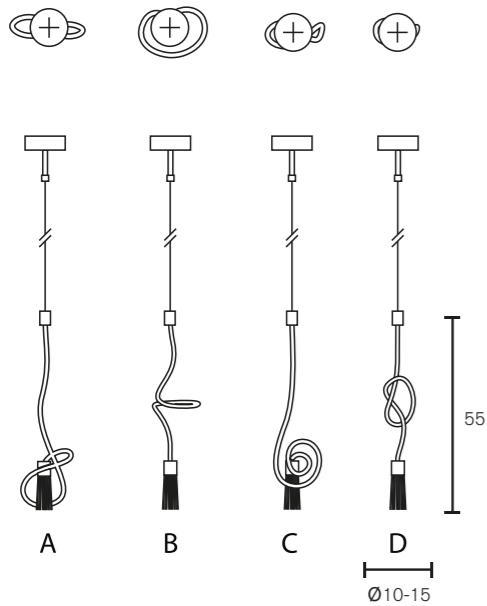

Element

Art.nr.	Dimensions	Light bulb	Weight	Finish
100SOSST	Ø30xH.100 cm	1x E14	2,5 kg	stainless steel

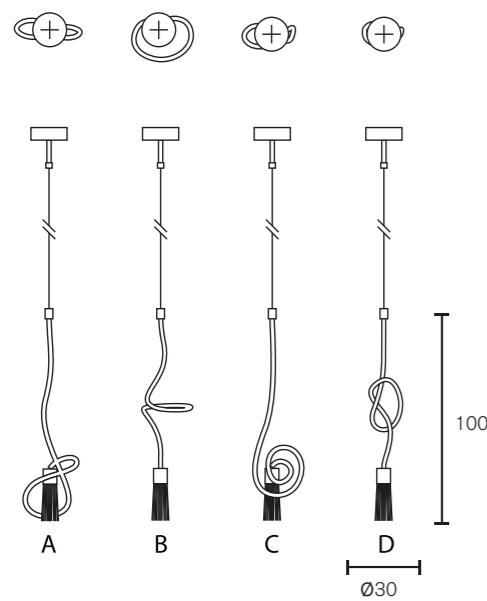

All elements are supplied with 3 meter steel cable, 3 meter electrical cable and a ceiling shade

Technical information

Collection La Vie En Rose 2014

A bouquet can be connected on its own with a ceiling cover or, when used as part of a composition, connected with a ceiling screw and attached with a electric cable to the central pot of the composition.

The Single Rose Decorative can be connected to a ceiling as part of a composition. It can also be connected straight to the ceiling on its own using a ceiling screw.

A Single Rose with Light can be connected to a central pot as part of a composition. On its own a Single Rose with Light can be connected with a ceiling cover.

Optional Compositions with a central pot

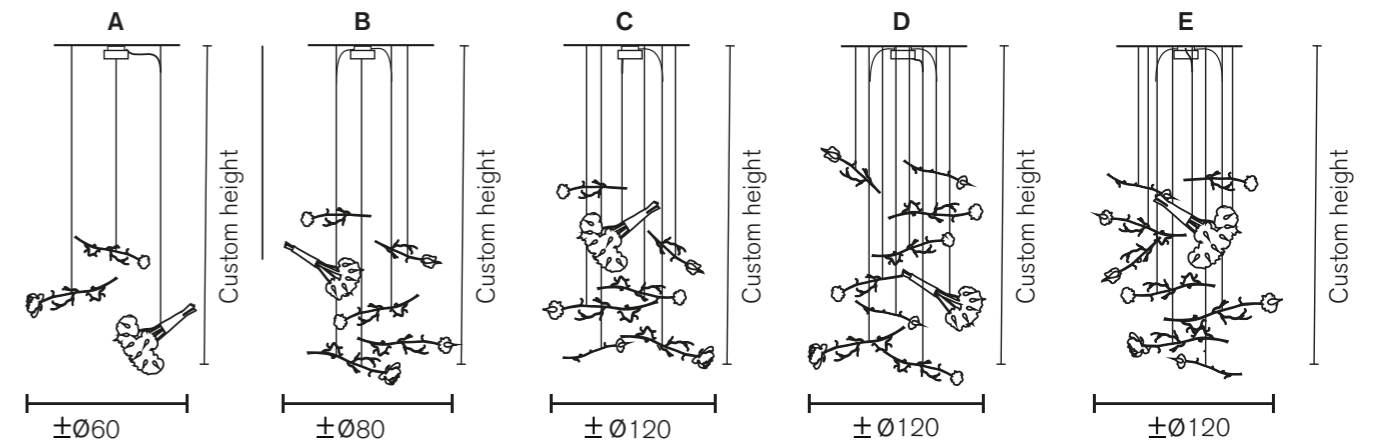

Bouquet

Art.nr.	Dimensions	Light bulb	Weight	Finish
VERHB40N	Ø40xL.80 cm	5x E14	10,0 kg	nickel finish
VERHB60N	Ø60xL.80 cm	7x E14	11,0 kg	nickel finish
VERHB80N	Ø80xL.100 cm	10x E14	22,0 kg	nickel finish
VERHB100N	Ø100xL.120 cm	12x E14	30,0 kg	nickel finish

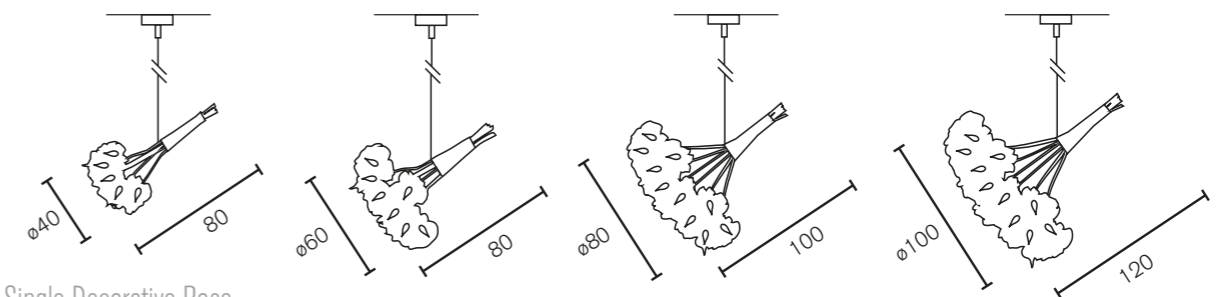

Single Decorative Rose

Art.nr.	Dimensions	Light bulb	Weight	Finish
VERSRD80N	L.85xW.20xH.20 cm		1,0 kg	nickel finish

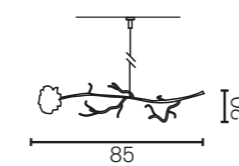

All bouquets are supplied with 3 meter steel cable, 3 meter electrical cable and a ceiling shade.
All single roses are standard delivered with 3 meter steel cable, 3 meter electrical cable and a ceiling shade. Decorative roses have no electrical cable.

Technical information

Single Light Rose

Art.nr.	Dimensions	Light bulb	Weight	Finish
VERSL80N	L.85xW.15xH.15 cm	1x E14	1,0 kg	nickel finish

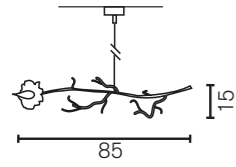

Hanging Lamp

Art.nr.	Dimensions	Light bulb	Weight	Finish
VERHL120N	L.120xW.40xH.40 cm	8x E14	5,0 kg	nickel finish
VERHL140N	L.140xW.40xH.40 cm	8x E14	8,5 kg	nickel finish
VERHL160N	L.160xW.40xH.40 cm	10x E14	11,0 kg	nickel finish

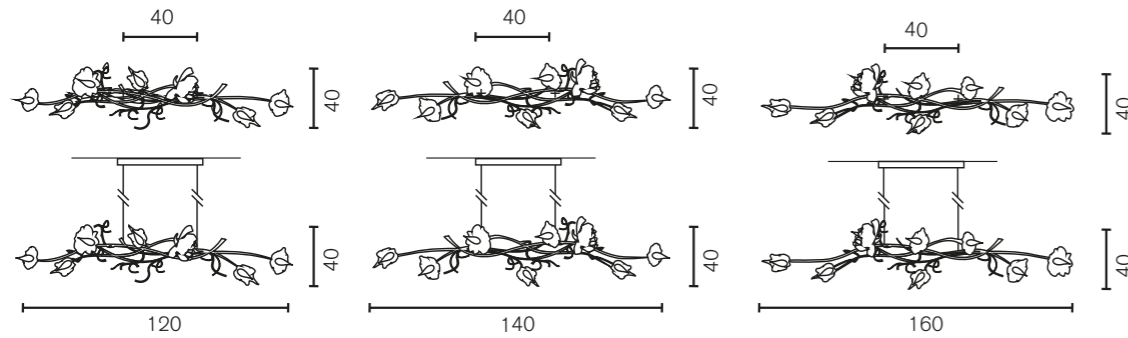

Wall Lamp

Art.nr.	Dimensions	Light bulb	Weight	Finish
VERW35N	L.35xH.65x D.20 cm	3x E14	8,0 kg	nickel finish

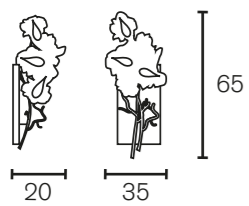

Technical information

Collection Love You Love You Not 2007

Chandelier Conical

Art.nr.	Dimensions	Light bulb	Weight	Finish
LYCC60BL	Ø60xH.70 cm	10x E14	22.0 kg	black finish
LYCC60W	Ø60xH.70 cm	10x E14	22.0 kg	white finish
LYCC60N	Ø60xH.70 cm	10x E14	22.0 kg	nickel finish
LYCC70BL	Ø70xH.80 cm	12x E14	28.0 kg	black finish
LYCC70W	Ø70xH.80 cm	12x E14	28.0 kg	white finish
LYCC70N	Ø70xH.80 cm	12x E14	28.0 kg	nickel finish

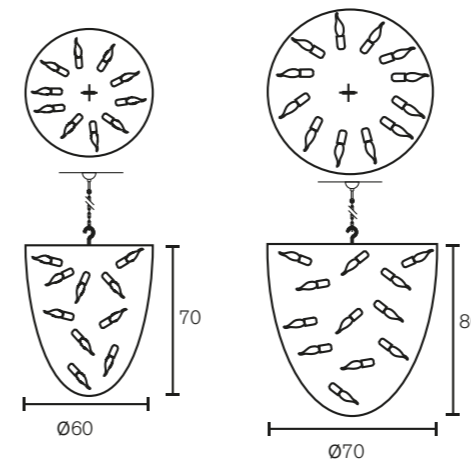

Chandelier Oval

Art.nr.	Dimensions	Light bulb	Weight	Finish
LYOC60BL	L.120xW.60xH.65 cm	16x E14	25.0 kg	black finish
LYOC60W	L.120xW.60xH.65 cm	16x E14	25.0 kg	white finish
LYOC60N	L.120xW.60xH.65 cm	16x E14	25.0 kg	nickel finish
LYOC70BL	L.140xW.70xH.65 cm	16x E14	26.0 kg	black finish
LYOC70W	L.140xW.70xH.65 cm	16x E14	26.0 kg	white finish
LYOC70N	L.140xW.70xH.65 cm	16x E14	26.0 kg	nickel finish
LYOC80BL	L.160xW.70xH.65 cm	18x E14	41.0 kg	black finish
LYOC80W	L.160xW.70xH.65 cm	18x E14	41.0 kg	white finish
LYOC80N	L.160xW.70xH.65 cm	18x E14	41.0 kg	nickel finish
LYOC100BL	L.200xW.70xH.65 cm	24x E14	65.0 kg	black finish
LYOC100W	L.200xW.70xH.65 cm	24x E14	65.0 kg	white finish
LYOC100N	L.200xW.70xH.65 cm	24x E14	65.0 kg	nickel finish

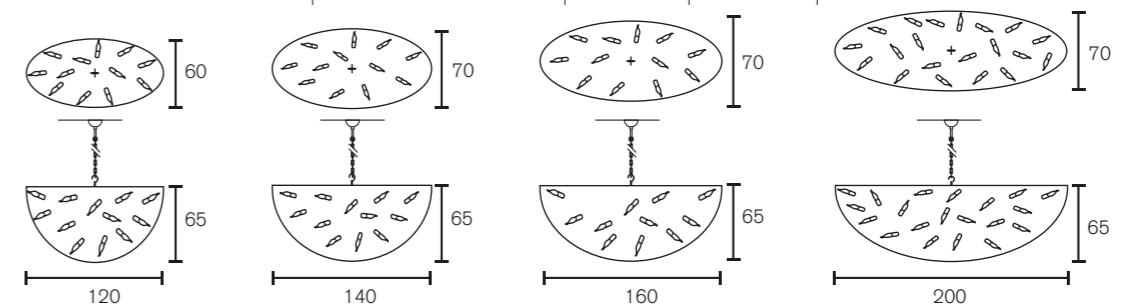

Due to our manual production method, amount and position of roses in Love You Love You Not Chandeliers may vary. Lights that will be combined in the same space should therefore be ordered at the same time.

All chandeliers are supplied with 1,7 meter chain, 2 meter electrical cable and a ceiling shade.

All hanging lamps are supplied with 3 meter steel cable, 3 meter electrical cable and a ceiling shade

Technical information

Chandelier Round

Art.nr.	Dimensions	Light bulb	Weight	Finish
LYC80BL	Ø80xH.45 cm	12x E14	22.0 kg	black finish
LYC80W	Ø80xH.45 cm	12x E14	22.0 kg	white finish
LYC80N	Ø80xH.45 cm	12x E14	22.0 kg	nickel finish
LYC100BL	Ø100xH.55 cm	14x E14	35.0 kg	black finish
LYC100W	Ø100xH.55 cm	14x E14	35.0 kg	white finish
LYC100N	Ø100xH.55 cm	14x E14	35.0 kg	nickel finish
LYC120BL	Ø120xH.70 cm	16x E14	55.0 kg	black finish
LYC120W	Ø120xH.70 cm	16x E14	55.0 kg	white finish
LYC120N	Ø120xH.70 cm	16x E14	55.0 kg	nickel finish
LYC140BL	Ø140xH.70 cm	18x E14	60.0 kg	black finish
LYC140W	Ø140xH.70 cm	18x E14	60.0 kg	white finish
LYC140N	Ø140xH.70 cm	18x E14	60.0 kg	nickel finish

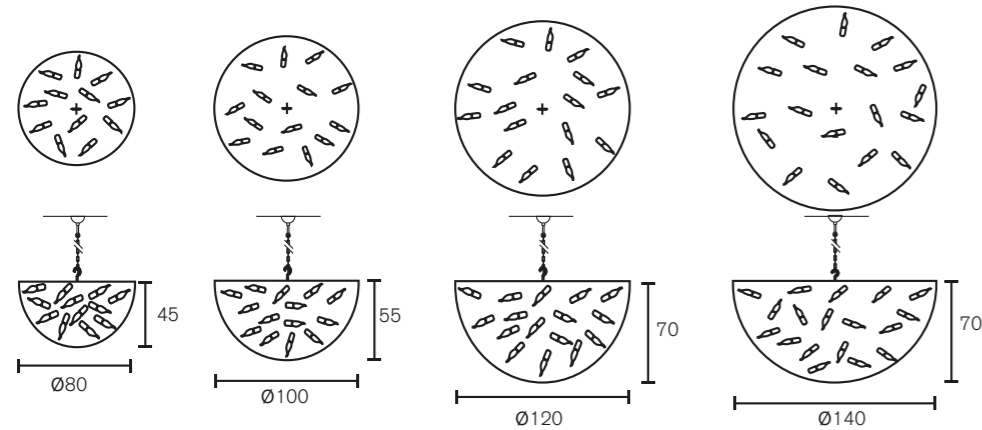

Technical information

Ceiling Lamp Round

Art.nr.	Dimensions	Light bulb	Weight	Finish
LYP60BL	Ø60xH.30 cm	6x E14	8.0 kg	black finish
LYP60W	Ø60xH.30 cm	6x E14	8.0 kg	white finish
LYP60N	Ø60xH.30 cm	6x E14	8.0 kg	nickel finish
LYP80BL	Ø80xH.30 cm	8x E14	13.0 kg	black finish
LYP80W	Ø80xH.30 cm	8x E14	13.0 kg	white finish
LYP80N	Ø80xH.30 cm	8x E14	13.0 kg	nickel finish
LYP100BL	Ø100xH.30 cm	10x E14	20.0 kg	black finish
LYP100W	Ø100xH.30 cm	10x E14	20.0 kg	white finish
LYP100N	Ø100xH.30 cm	10x E14	20.0 kg	nickel finish

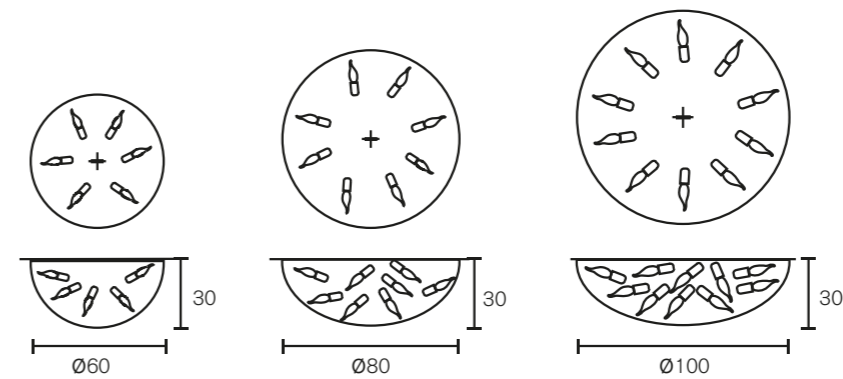

Wall Lamp

Art.nr.	Dimensions	Light bulb	Weight	Finish
LYW45BL-L	W.15xH.45xD.12 cm	1x E14	3.5 kg	black finish, left version
LYW45BL-R	W.15xH.45xD.12 cm	1x E14	3.5 kg	black finish, right version
LYW45W-L	W.15xH.45xD.12 cm	1x E14	3.5 kg	white finish, left version
LYW45W-R	W.15xH.45xD.12 cm	1x E14	3.5 kg	white finish, right version
LYW45N-L	W.15xH.45xD.12 cm	1x E14	3.5 kg	nickel finish, left version
LYW45N-R	W.15xH.45xD.12 cm	1x E14	3.5 kg	nickel finish, right version

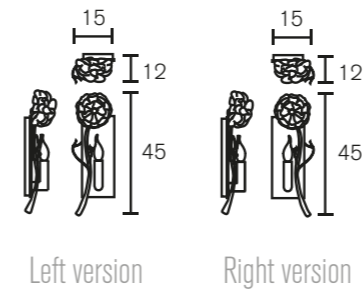

Due to our manual production method, amount and position of roses in Love You Love You Not Chandeliers may vary. Lights that will be combined in the same space should therefore be ordered at the same time.

All chandeliers are supplied with 1,7 meter chain, 2 meter electrical cable and a ceiling shade.

Technical information

Collection Flower Power 2005

Chandelier Oval

Art.nr.	Dimensions	Light bulb	Weight	Finish
FPHO115BL	L.115xW.65xH.40 cm	12x G9	28,0 kg	black finish
FPHO115W	L.115xW.65xH.40 cm	12x G9	28,0 kg	white finish
FPHO115N	L.115xW.65xH.40 cm	12x G9	28,0 kg	nickel finish
FPHO135BL	L.135xW.65xH.45 cm	12x G9	35,0 kg	black finish
FPHO135W	L.135xW.65xH.45 cm	12x G9	35,0 kg	white finish
FPHO135N	L.135xW.65xH.45 cm	12x G9	35,0 kg	nickel finish
FPHO155BL	L.155xW.65xH.45 cm	12x G9	40,0 kg	black finish
FPHO155W	L.155xW.65xH.45 cm	12x G9	40,0 kg	white finish
FPHO155N	L.155xW.65xH.45 cm	12x G9	40,0 kg	nickel finish

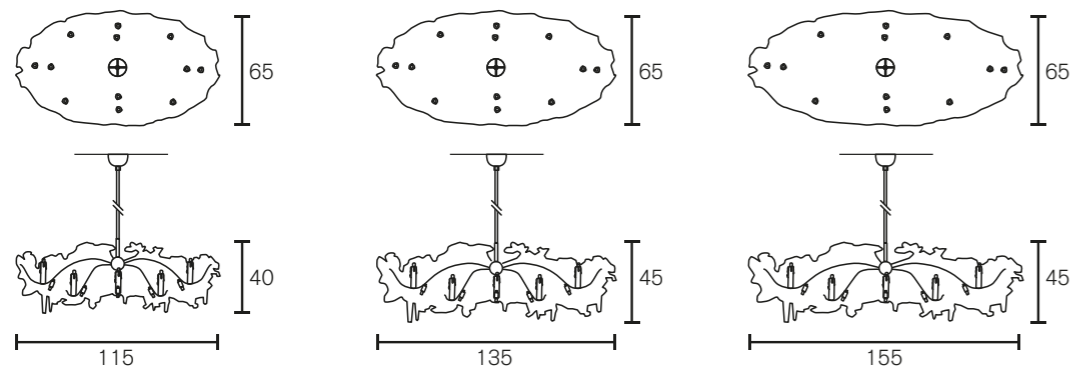

All chandeliers are supplied with 2 meter stem and a ceiling shade..

Technical information

Collection Icy Lady 2005

Chandelier Oval

Art.nr.	Dimensions	Light bulb	Weight	Finish
ILCO115BL	L.115xW.65xH.40 cm	12x G9	27,0 kg	black finish
ILCO115W	L.115xW.65xH.40 cm	12x G9	27,0 kg	white finish
ILCO115N	L.115xW.65xH.40 cm	12x G9	27,0 kg	nickel finish
ILCO135BL	L.135xW.65xH.45 cm	12x G9	30,0 kg	black finish
ILCO135W	L.135xW.65xH.45 cm	12x G9	30,0 kg	white finish
ILCO135N	L.135xW.65xH.45 cm	12x G9	30,0 kg	nickel finish
ILCO155BL	L.155xW.65xH.45 cm	12x G9	40,0 kg	black finish
ILCO155W	L.155xW.65xH.45 cm	12x G9	40,0 kg	white finish
ILCO155N	L.155xW.65xH.45 cm	12x G9	40,0 kg	nickel finish

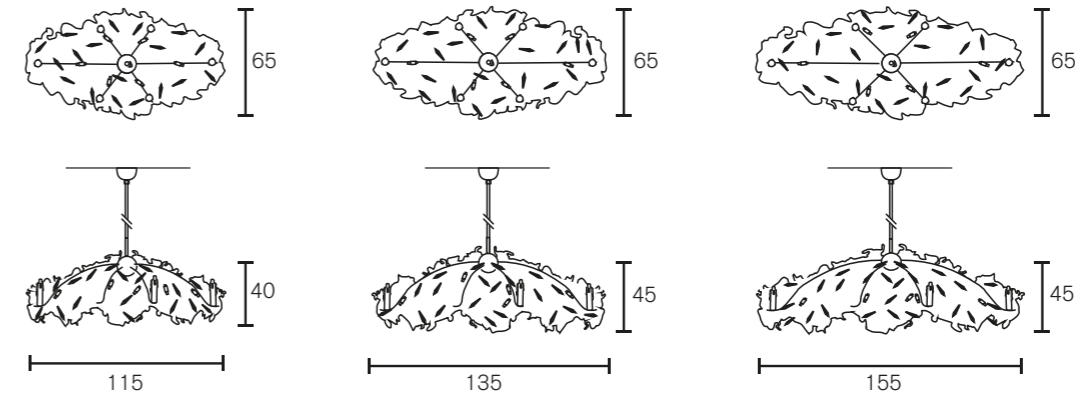

All chandeliers are supplied with 2 meter stem and a ceiling shade. All crystals are original Swarovski crystals

Technical information

Chandelier Round Upside Down

Art.nr.	Dimensions	Light bulb	Weight	Finish
ILCUSD60BL	Ø60xH.30 cm	10x G9	28.0 kg	black finish
ILCUSD60W	Ø60xH.30 cm	10x G9	28.0 kg	white finish
ILCUSD60N	Ø60xH.30 cm	10x G9	28.0 kg	nickel finish
ILCUSD80BL	Ø80xH.37 cm	12x G9	29.5 kg	black finish
ILCUSD80W	Ø80xH.37 cm	12x G9	29.5 kg	white finish
ILCUSD80N	Ø80xH.37 cm	12x G9	29.5 kg	nickel finish
ILCUSD100BL	Ø100xH.45 cm	15x G9	36.0 kg	black finish
ILCUSD100W	Ø100xH.45 cm	15x G9	36.0 kg	white finish
ILCUSD100N	Ø100xH.45 cm	15x G9	36.0 kg	nickel finish
ILCUSD120BL	Ø120xH.55 cm	18x G9	46.0 kg	black finish
ILCUSD120W	Ø120xH.55 cm	18x G9	46.0 kg	white finish
ILCUSD120N	Ø120xH.55 cm	18x G9	46.0 kg	nickel finish

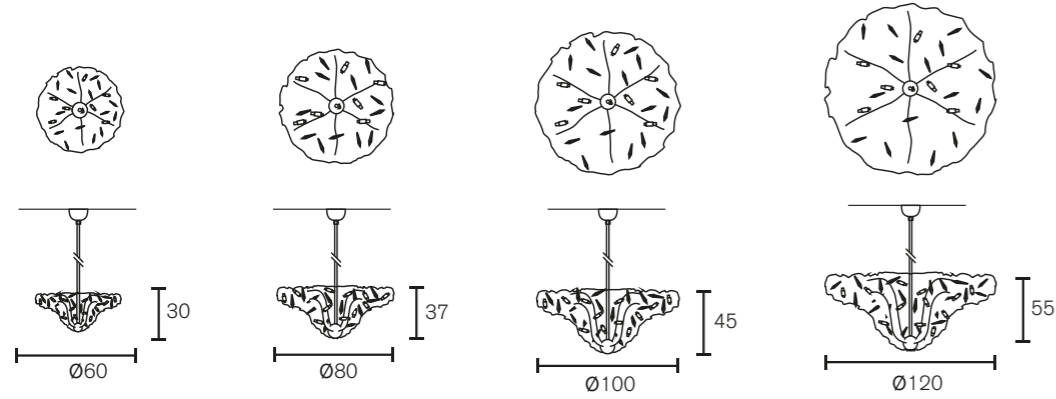

Hanging Lamp Round

Art.nr.	Dimensions	Light bulb	Weight	Finish
ILC80BL	Ø80xH.35 cm	12x G9	23.0 kg	black finish
ILC80W	Ø80xH.35 cm	12x G9	23.0 kg	white finish
ILC80N	Ø80xH.35 cm	12x G9	23.0 kg	nickel finish
ILC100BL	Ø100xH.45 cm	12x G9	34.0 kg	black finish
ILC100W	Ø100xH.45 cm	12x G9	34.0 kg	white finish
ILC100N	Ø100xH.45 cm	12x G9	34.0 kg	nickel finish
ILC120BL	Ø120xH.55 cm	12x G9	52.0 kg	black finish
ILC120W	Ø120xH.55 cm	12x G9	52.0 kg	white finish
ILC120N	Ø120xH.55 cm	12x G9	52.0 kg	nickel finish

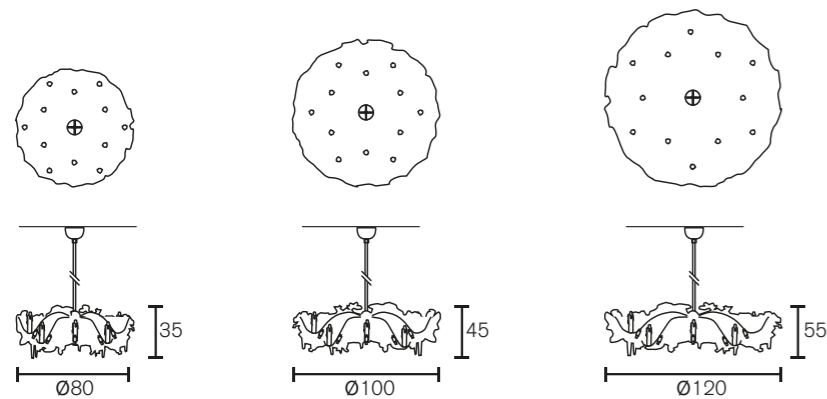

All chandeliers are supplied with 2 meter stem and a ceiling shade.
Hanging lamps are supplied with 2 meter stem and a ceiling shade.
All crystals are original Swarovski crystals

Technical information

Ceiling Lamp Round

Art.nr.	Dimensions	Light bulb	Weight	Finish
ILP60BL	Ø60xH.30 cm	10x G9	13.0 kg	black finish
ILP60W	Ø60xH.30 cm	10x G9	13.0 kg	white finish
ILP60N	Ø60xH.30 cm	10x G9	13.0 kg	nickel finish
ILP80BL	Ø80xH.35 cm	12x G9	18.0 kg	black finish
ILP80W	Ø80xH.35 cm	12x G9	18.0 kg	white finish
ILP80N	Ø80xH.35 cm	12x G9	18.0 kg	nickel finish
ILP100BL	Ø100xH.40 cm	12x G9	26.0 kg	black finish
ILP100W	Ø100xH.40 cm	12x G9	26.0 kg	white finish
ILP100N	Ø100xH.40 cm	12x G9	26.0 kg	nickel finish
ILP120BL	Ø120xH.45 cm	15x G9	35.0 kg	black finish
ILP120W	Ø120xH.45 cm	15x G9	35.0 kg	white finish
ILP120N	Ø120xH.45 cm	15x G9	35.0 kg	nickel finish

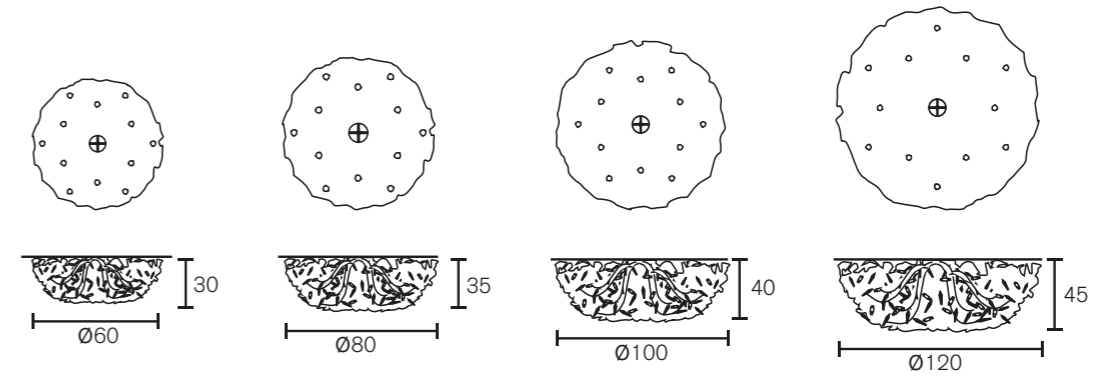

Wall Lamp

Art.nr.	Dimensions	Light bulb	Weight	Finish
ILW30BL-L	W.30xH.40xD.14 cm	1x E14	3.0 kg	black finish, left version
ILW30BL-R	W.30xH.40xD.14 cm	1x E14	3.0 kg	black finish, right version
ILW30W-L	W.30xH.40xD.14 cm	1x E14	3.0 kg	white finish, left version
ILW30W-R	W.30xH.40xD.14 cm	1x E14	3.0 kg	white finish, right version
ILW30N-L	W.30xH.40xD.14 cm	1x E14	3.0 kg	nickel finish, left version
ILW30N-R	W.30xH.40xD.14 cm	1x E14	3.0 kg	nickel finish, right version

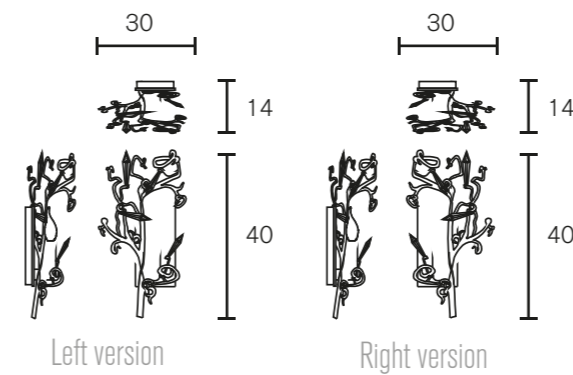

All crystals are original Swarovski crystals.

Technical information

Collection Crystal Waters 1999

Hanging Lamp Ufo

Art.nr.	Dimensions	Light bulb	Weight	Finish
CWH60NH	Ø60xH.90 cm	16x G9	12,0 kg	nickel finish
CWH59NH	Ø60xH.30 cm	12x G9	7,0 kg	nickel finish
CWH80NH	Ø80xH.30 cm	16x G9	10,0 kg	nickel finish
CWH100NH	Ø100xH.30 cm	20x G9	13,0 kg	nickel finish

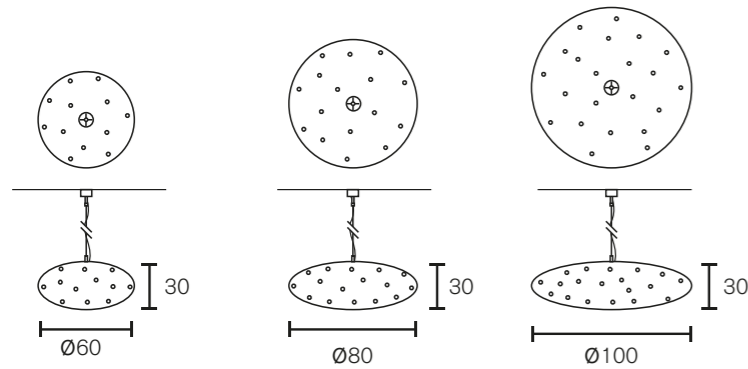

Hanging Lamp Cigar

Art.nr.	Dimensions	Light bulb	Weight	Finish
CWS100NH	L.100xW.42xH.28 cm	12x G9	6,0 kg	nickel finish
CWS130NH	L.130xW.50xH.30 cm	16x G9	8,0 kg	nickel finish
CWS160NH	L.160xW.55xH.30 cm	22x G9	12,0 kg	nickel finish
CWS200NH	L.200xW.55xH.30 cm	26x G9	15,0 kg	nickel finish

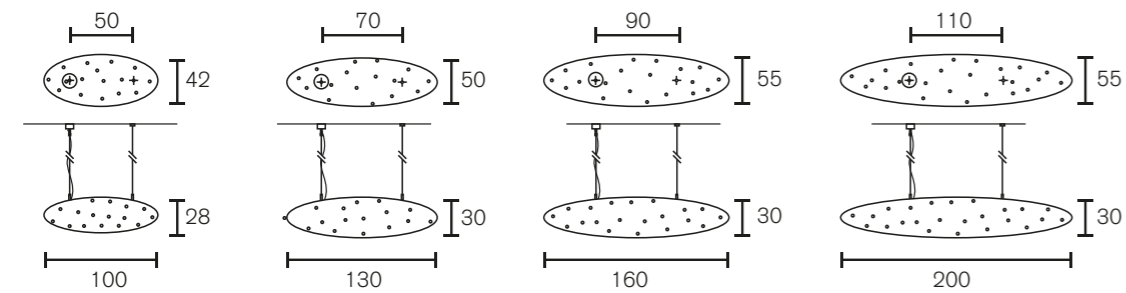

All hanging lamps are supplied with 3 meter steel cable, 3 meter electrical cable and a ceiling shade.

Technical information

Hanging Lamp Drop

Art.nr.	Dimensions	Light bulb	Weight	Finish
CWH130NH	Ø30xH.130 cm	14x G9	9,0 kg	nickel finish
CWH160NH	Ø35xH.160 cm	18x G9	11,0 kg	nickel finish
CWH200NH	Ø40xH.200 cm	24x G9	15,0 kg	nickel finish

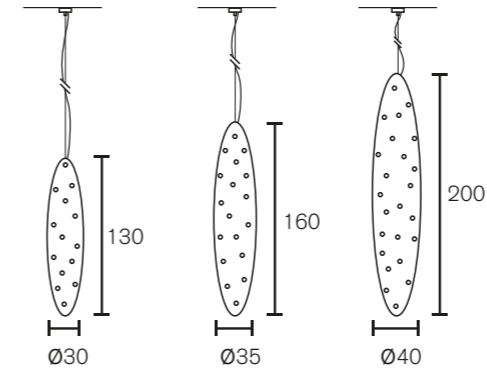

Ceiling Lamp Round

Art.nr.	Dimensions	Light bulb	Weight	Finish
CWP40NH	Ø40xH.28 cm	7x G9	4,0 kg	nickel finish
CWP60NH	Ø60xH.38 cm	10x G9	5,0 kg	nickel finish
CWP80NH	Ø80xH.38 cm	13x G9	10,0 kg	nickel finish
CWP100NH	Ø100xH.38 cm	16x G9	12,0 kg	nickel finish
CWP120NH	Ø120xH.38 cm	17x G9	16,0 kg	nickel finish

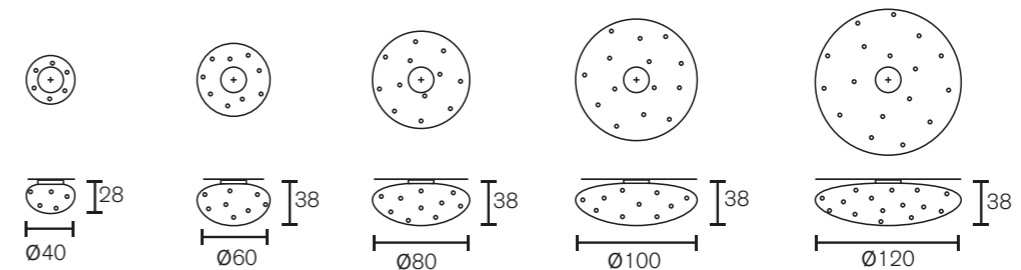

Wall Lamp

Art.nr.	Dimensions	Light bulb	Weight	Finish
150CW1N	W.20xH.27xD.17 cm	1x E14	3,0 kg	nickel finish



All hanging lamps are supplied with 3 meter steel cable, 3 meter electrical cable and a ceiling shade.

Technical information

Collection Delphinium 1998

Chandelier Conical

Art.nr.	Dimensions	Light bulb	Weight	Finish
DCC60N	Ø60xH.70 cm	8x E14	20,0 kg	nickel finish
DCC70N	Ø70xH.80 cm	10x E14	25,0 kg	nickel finish

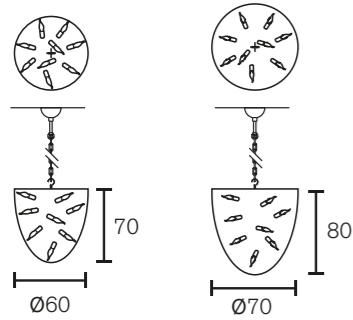

Chandelier Oval

Art.nr.	Dimensions	Light bulb	Weight	Finish
DOC60N	L.120xW.60xH.55 cm	12x E14	27,0 kg	nickel finish
DOC70N	L.140xW.70xH.55 cm	12x E14	29,0 kg	nickel finish
DOC80N	L.160xW.70xH.55 cm	16x E14	40,0 kg	nickel finish
DOC100N	L.200xW.70xH.70 cm	20x E14	58,0 kg	nickel finish

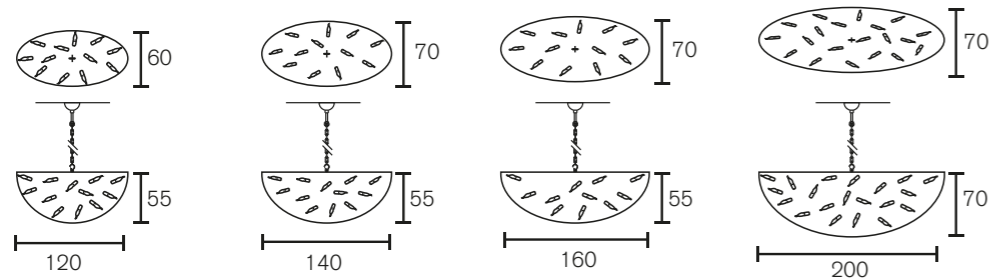

Chandelier Round

Art.nr.	Dimensions	Light bulb	Weight	Finish
DC80N	Ø80xH.45 cm	10x E14	21,0 kg	nickel finish
DC100N	Ø100xH.55 cm	12x E14	27,0 kg	nickel finish
DC120N	Ø120xH.70 cm	16x E14	35,0 kg	nickel finish
DC140N	Ø140xH.70 cm	20x E14	67,0 kg	nickel finish

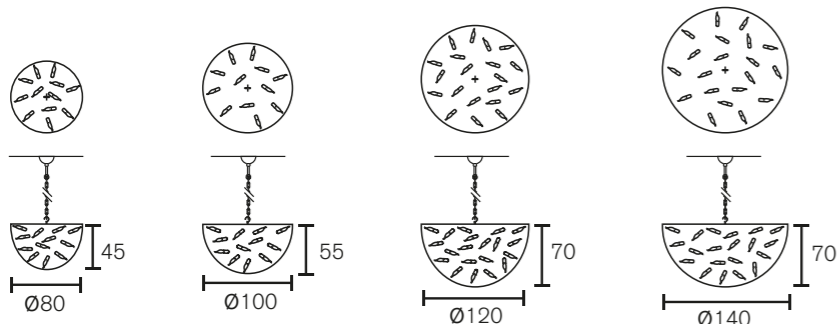

Technical information

Ceiling Lamp Round

Art.nr.	Dimensions	Light bulb	Weight	Finish
DP60N	Ø60xH.30 cm	5x E14	11,0 kg	nickel finish
DP80N	Ø80xH.35 cm	6x E14	17,0 kg	nickel finish
DP100N	Ø100xH.40 cm	8x E14	26,0 kg	nickel finish
DP120N	Ø120xH.40 cm	10x E14	40,0 kg	nickel finish

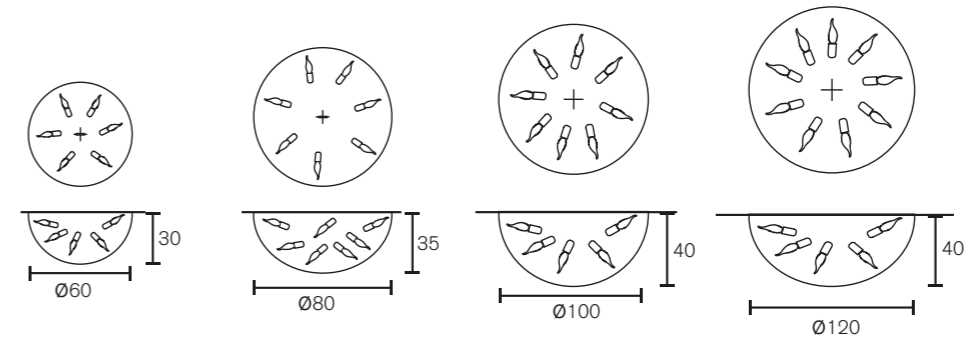

Wall Lamp

Art.nr.	Dimensions	Light bulb	Weight	Finish
DW35N	W.40xH.75xD.20 cm	3x E14	7,0 kg	nickel finish

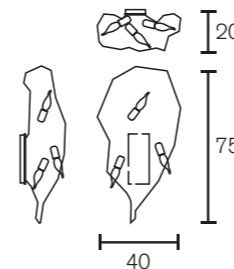

Technical information

Collection Hollywood 1996

Chandelier Conical

Art.nr.	Dimensions	Light bulb	Weight	Finish
HCC40W	Ø40xH.60 cm	6x E14	6,0 kg	white finish
HCC40N	Ø40xH.60 cm	6x E14	6,0 kg	nickel finish
HCC60W	Ø60xH.100 cm	8x E14	16,0 kg	white finish
HCC60N	Ø60xH.100 cm	8x E14	16,0 kg	nickel finish
HCC90W	Ø90xH.130 cm	16x E14	27,0 kg	white finish
HCC90N	Ø90xH.130 cm	16x E14	27,0 kg	nickel finish

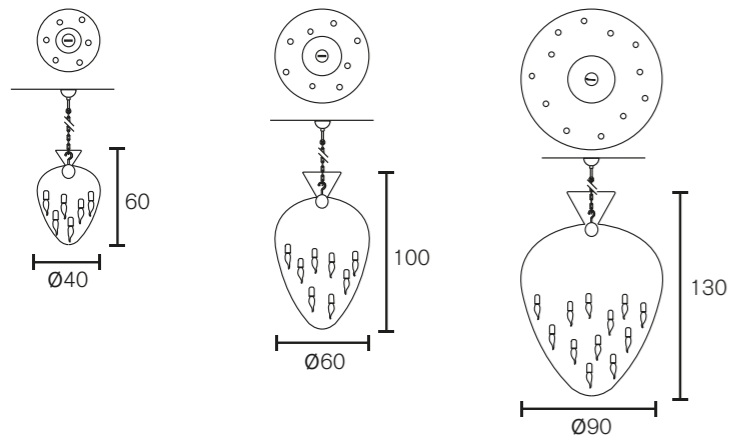

Chandelier Conical Oval

Art.nr.	Dimensions	Light bulb	Weight	Finish
HCCO120W	L.120xW.55xH.75 cm	12x E14	23,0 kg	white finish
HCCO120N	L.120xW.55xH.75 cm	12x E14	23,0 kg	nickel finish
HCCO140W	L.140xW.55xH.85 cm	14x E14	26,0 kg	white finish
HCCO140N	L.140xW.55xH.85 cm	14x E14	26,0 kg	nickel finish
HCCO160W	L.160xW.55xH.85 cm	14x E14	30,0 kg	white finish
HCCO160N	L.160xW.55xH.85 cm	14x E14	30,0 kg	nickel finish

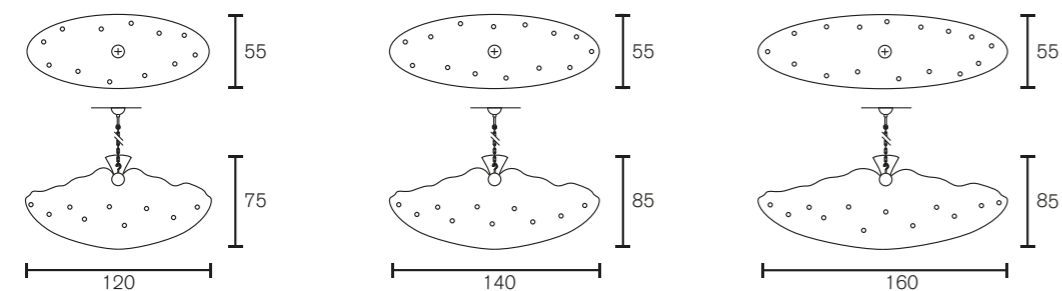

Due to our manual production method, shape and structure in Hollywood Chandeliers may vary. Lights that will be combined in the same space should therefore be ordered at the same time.

All chandeliers are supplied with 1,7 meter chain, 2 meter electrical cable and a ceiling shade.

Technical information

Chandelier Oval

Art.nr.	Dimensions	Light bulb	Weight	Finish
HOC60W	L.120xW.60xH.25 cm	8x E14	13,0 kg	white finish
HOC60N	L.120xW.60xH.25 cm	8x E14	13,0 kg	nickel finish
HOC70W	L.140xW.70xH.25 cm	8x E14	17,0 kg	white finish
HOC70N	L.140xW.70xH.25 cm	8x E14	17,0 kg	nickel finish
HOC80W	L.160xW.80xH.25 cm	8x E14	24,0 kg	white finish
HOC80N	L.160xW.80xH.25 cm	8x E14	24,0 kg	nickel finish
HOC100W	L.200xW.100xH.25 cm	12x E14	38,0 kg	white finish
HOC100N	L.200xW.100xH.25 cm	12x E14	38,0 kg	nickel finish

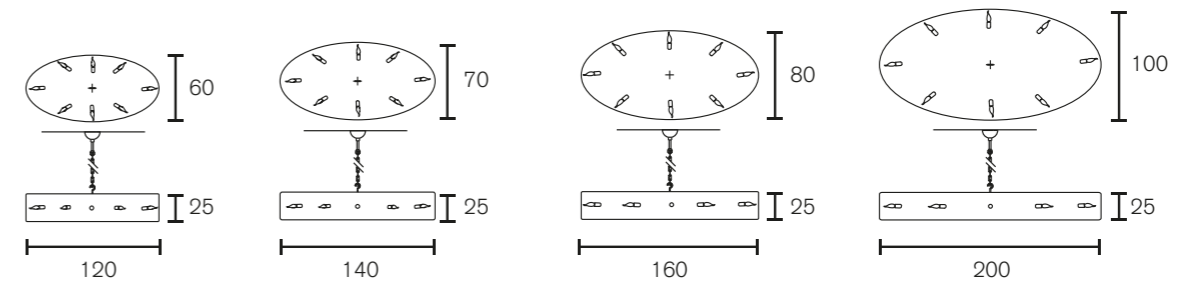

Chandelier Round

Art.nr.	Dimensions	Light bulb	Weight	Finish
HC80W	Ø80xH.25 cm	6x E14	11,0 kg	white finish
HC80N	Ø80xH.25 cm	6x E14	11,0 kg	nickel finish
HC100W	Ø100xH.25 cm	8x E14	25,0 kg	white finish
HC100N	Ø100xH.25 cm	8x E14	25,0 kg	nickel finish
HC120W	Ø120xH.25 cm	10x E14	28,0 kg	white finish
HC120N	Ø120xH.25 cm	10x E14	28,0 kg	nickel finish

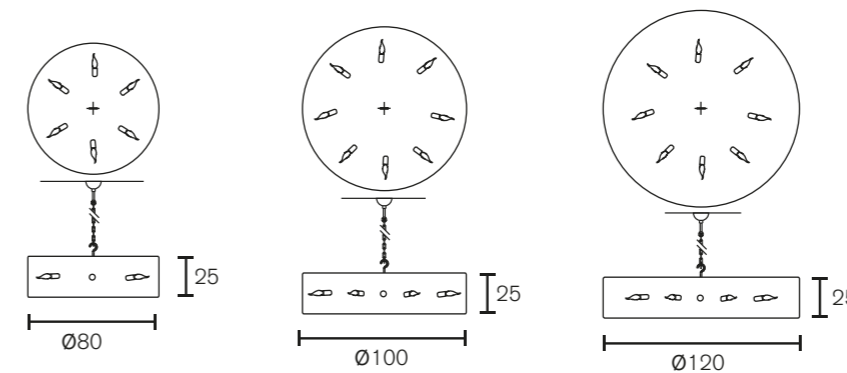

Due to our manual production method, shape and structure in Hollywood Chandeliers may vary. Lights that will be combined in the same space should therefore be ordered at the same time.

All chandeliers are supplied with 1,7 meter chain, 2 meter electrical cable and a ceiling shade.

Technical information

Chandelier Candlestick Round

Art.nr.	Dimensions	Light bulb	Weight	Finish
HCCH10X10W	Ø100xH.40 cm	12x E14	21,0 kg	white finish
HCCH10X10N	Ø100xH.40 cm	12x E14	21,0 kg	nickel finish
HCCH12X12W	Ø120xH.40 cm	12x E14	25,0 kg	white finish
HCCH12X12N	Ø120xH.40 cm	12x E14	25,0 kg	nickel finish

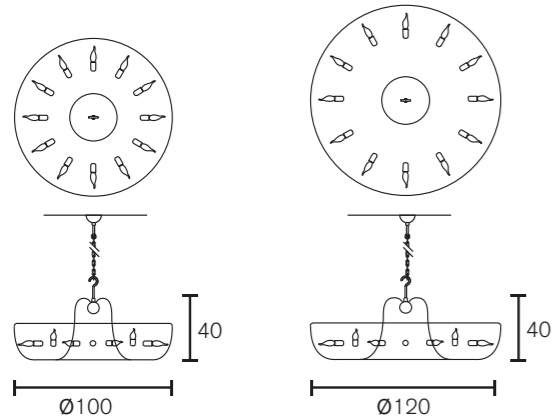

Hanging Lamp InLine

Art.nr.	Dimensions	Light bulb	Weight	Finish
HH25N	Ø25xH.30 cm	1x E27	4,0 kg	nickel finish
HH25N-3IL	L.90xW.25xH.30 cm	3x E27	34,0 kg	nickel finish
HH25N-4IL	L.145xW.25xH.30 cm	4x E27	37,0 kg	nickel finish
HH25N-5IL	L.225xW.25xH.30 cm	5x E27	40,0 kg	nickel finish
HH25N-6IL	L.235xW.25xH.30 cm	6x E27	43,0 kg	nickel finish

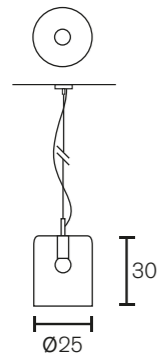

Due to our manual production method, shape and structure in Hollywood Chandeliers may vary. Lights that will be combined in the same space should therefore be ordered at the same time.

All hanging lamps are supplied with 3 meter steel cable, 3 meter electrical cable and a ceiling shade

Technical information

Hanging Lamp Long

Art.nr.	Dimensions	Light bulb	Weight	Finish
HHL100W	L.100xW.25xH.30 cm	4x E27	13,0 kg	white finish
HHL100N	L.100xW.25xH.30 cm	4x E27	13,0 kg	nickel finish
HHL125W	L.125xW.25xH.30 cm	5x E27	18,0 kg	white finish
HHL125N	L.125xW.25xH.30 cm	5x E27	18,0 kg	nickel finish
HHL150W	L.150xW.25xH.30 cm	6x E27	18,0 kg	white finish
HHL150N	L.150xW.25xH.30 cm	6x E27	18,0 kg	nickel finish
HHL175W	L.175xW.25xH.30 cm	7x E27	21,0 kg	white finish
HHL175N	L.175xW.25xH.30 cm	7x E27	21,0 kg	nickel finish
HHL200W	L.200xW.25xH.30 cm	8x E27	25,0 kg	white finish
HHL200N	L.200xW.25xH.30 cm	8x E27	25,0 kg	nickel finish

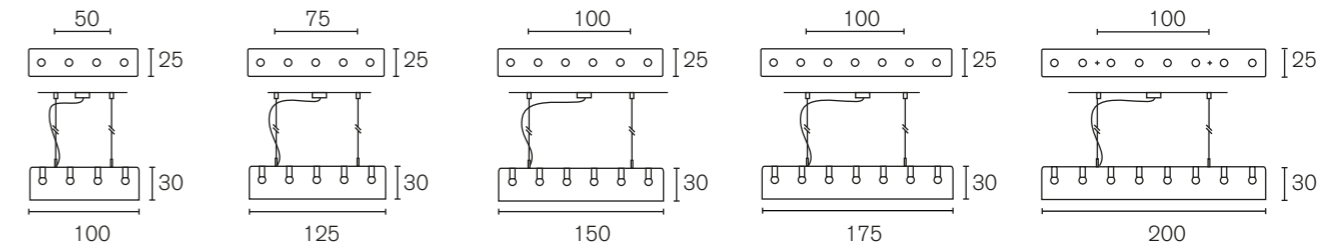

Hanging Lamp Block

Art.nr.	Dimensions	Light bulb	Weight	Finish
HCC50W	L.40xW.40xH.50 cm	1x E27	13,0 kg	white finish
HCC50N	L.40xW.40xH.50 cm	1x E27	13,0 kg	nickel finish

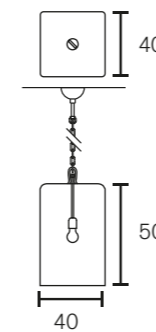

All hanging lamps are supplied with 3 meter steel cable, 3 meter electrical cable and a ceiling shade

The Hollywood Hanging Lamp Long is supplied with a small ceiling shade.

Long ceiling shade with two steel cable connections available on request.

The Hanging Lamp Block is supplied with 1,7 meter chain, 2 meter electrical cable and a ceiling shade.

Technical information

Ceiling Lamp Round

Art.nr.	Dimensions	Light bulb	Weight	Finish
HP40NH	Ø40xH.25 cm	6x G9	3,0 kg	nickel finish
HP60W	Ø60xH.25 cm	6x E14	6,0 kg	white finish
HP60N	Ø60xH.25 cm	6x E14	6,0 kg	nickel finish
HP80W	Ø80xH.25 cm	6x E14	10,0 kg	white finish
HP80N	Ø80xH.25 cm	6x E14	10,0 kg	nickel finish
HP100W	Ø100xH.25 cm	8x E14	16,0 kg	white finish
HP100N	Ø100xH.25 cm	8x E14	16,0 kg	nickel finish
HP120W	Ø120xH.25 cm	10x E14	24,0 kg	white finish
HP120N	Ø120xH.25 cm	10x E14	24,0 kg	nickel finish

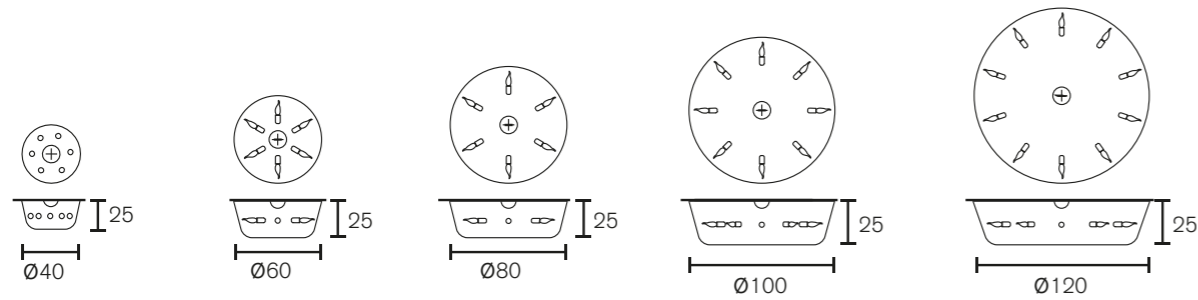

Ceiling Chandelier

Art.nr.	Dimensions	Light bulb	Weight	Finish
HPH40W	Ø40xH.40 cm	6x E14	5,0 kg	white finish
HPH40N	Ø40xH.40 cm	6x E14	5,0 kg	nickel finish
HPH60W	Ø60xH.60 cm	10x E14	8,0 kg	white finish
HPH60N	Ø60xH.60 cm	10x E14	8,0 kg	nickel finish
HPH80W	Ø80xH.80 cm	12x E14	11,0 kg	white finish
HPH80N	Ø80xH.80 cm	12x E14	11,0 kg	nickel finish
HPH100W	Ø100xH.80 cm	14x E14	15,0 kg	white finish
HPH100N	Ø100xH.80 cm	14x E14	15,0 kg	nickel finish
HPH120W	Ø120xH.80 cm	14x E14	17,0 kg	white finish
HPH120N	Ø120xH.80 cm	14x E14	17,0 kg	nickel finish

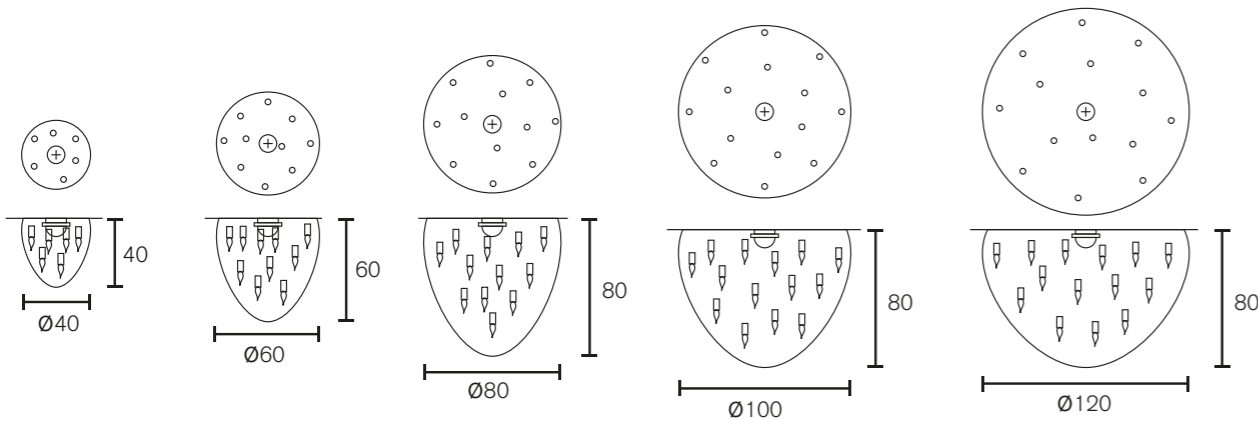

Technical information

Floor Lamp Block

Art.nr.	Dimensions	Light bulb	Weight	Finish
HF170W	L.30xW.30xH.170 cm	1x E27	18,0 kg	white finish
HF170N	L.30xW.30xH.170 cm	1x E27	18,0 kg	nickel finish
HF190W	L.40xW.40xH.190 cm	1x E27	23,0 kg	white finish
HF190N	L.40xW.40xH.190 cm	1x E27	23,0 kg	nickel finish

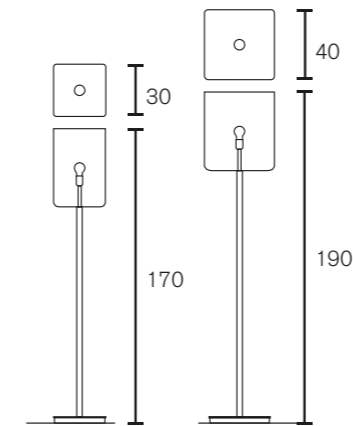
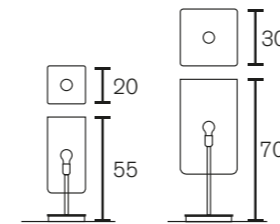

Table Lamp Block

Art.nr.	Dimensions	Light bulb	Weight	Finish
HT55W	L.20xW.20xH.55 cm	1x E27	6,5 kg	white finish
HT55N	L.20xW.20xH.55 cm	1x E27	6,5 kg	nickel finish
HT70W	L.30xW.30xH.70 cm	1x E27	14,0 kg	white finish
HT70N	L.30xW.30xH.70 cm	1x E27	14,0 kg	nickel finish



All floor- and table lamps are supplied with a dimmer.

Technical information

Wall Lamp

Art.nr.	Dimensions	Light bulb	Weight	Finish
HW20W-L	W.20xH.45xD.15 cm	1x E14	1,0 kg	white finish, left version
HW20W-R	W.20xH.45xD.15 cm	1x E14	1,0 kg	white finish, right version
HW20N-L	W.20xH.45xD.15 cm	1x E14	1,0 kg	nickel finish, left version
HW20N-R	W.20xH.45xD.15 cm	1x E14	1,0 kg	nickel finish, right version
HW30W-L	W.30xH.50xD.15 cm	1x E14	2,0 kg	white finish, left version
HW30W-R	W.30xH.50xD.15 cm	1x E14	2,0 kg	white finish, right version
HW30N-L	W.30xH.50xD.15 cm	1x E14	2,0 kg	nickel finish, left version
HW30N-R	W.30xH.50xD.15 cm	1x E14	2,0 kg	nickel finish, right version

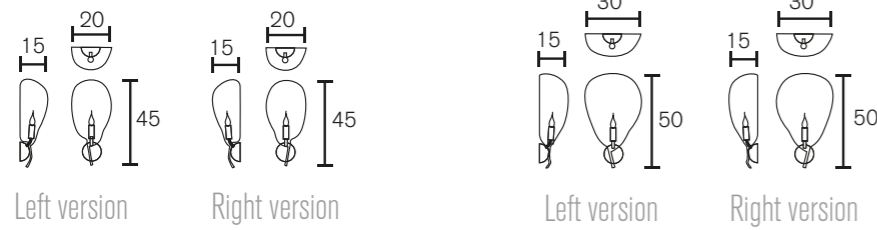

Wall Lamp Block

Art.nr.	Dimensions	Light bulb	Weight	Finish
HW45N	W.20xH.45xD.25 cm	1x E27	6,0 kg	nickel finish

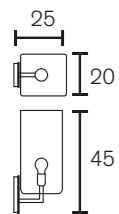

Technical information

Collection Hollywood Glass 1996

Chandelier Conical Glass

Art.nr.	Dimensions	Light bulb	Weight	Finish
HCCGL60BL	Ø60xH.75 cm	8x E14	16,0 kg	black finish
HCCGL60W	Ø60xH.75 cm	8x E14	16,0 kg	white finish
HCCGL60N	Ø60xH.75 cm	8x E14	16,0 kg	nickel finish
HCCGL80BL	Ø80xH.100 cm	12x E14	33,0 kg	black finish
HCCGL80W	Ø80xH.100 cm	12x E14	33,0 kg	white finish
HCCGL80N	Ø80xH.100 cm	12x E14	33,0 kg	nickel finish
HCCGL100BL	Ø100xH.125 cm	16x E14	44,0 kg	black finish
HCCGL100W	Ø100xH.125 cm	16x E14	44,0 kg	white finish
HCCGL100N	Ø100xH.125 cm	16x E14	44,0 kg	nickel finish
HCCGL120BL	Ø120xH.150 cm	20x E14	57,0 kg	black finish
HCCGL120W	Ø120xH.150 cm	20x E14	57,0 kg	white finish
HCCGL120N	Ø120xH.150 cm	20x E14	57,0 kg	nickel finish

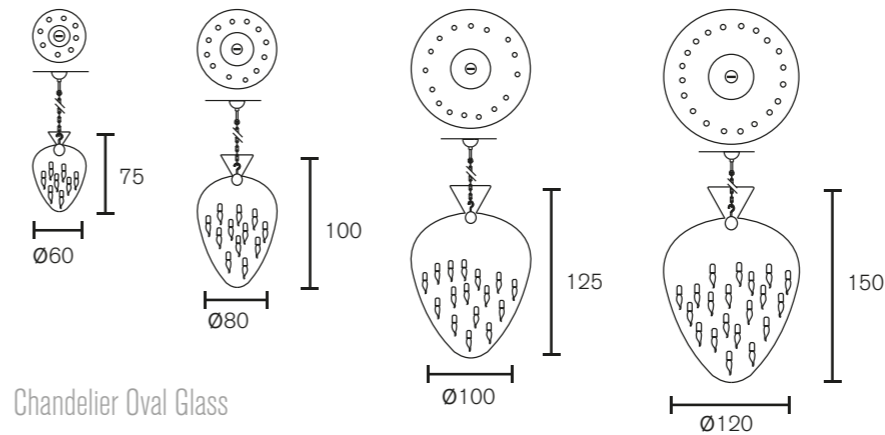

Chandelier Oval Glass

Art.nr.	Dimensions	Light bulb	Weight	Finish
HOCGL120BL	L.120xW.55xH.75 cm	12x E14	32,0 kg	black finish
HOCGL120W	L.120xW.55xH.75 cm	12x E14	32,0 kg	white finish
HOCGL120N	L.120xW.55xH.75 cm	12x E14	32,0 kg	nickel finish
HOCGL140BL	L.140xW.55xH.85 cm	14x E14	37,0 kg	black finish
HOCGL140W	L.140xW.55xH.85 cm	14x E14	37,0 kg	white finish
HOCGL140N	L.140xW.55xH.85 cm	14x E14	37,0 kg	nickel finish
HOCGL160BL	L.160xW.55xH.85 cm	16x E14	49,0 kg	black finish
HOCGL160W	L.160xW.55xH.85 cm	16x E14	49,0 kg	white finish
HOCGL160N	L.160xW.55xH.85 cm	16x E14	49,0 kg	nickel finish

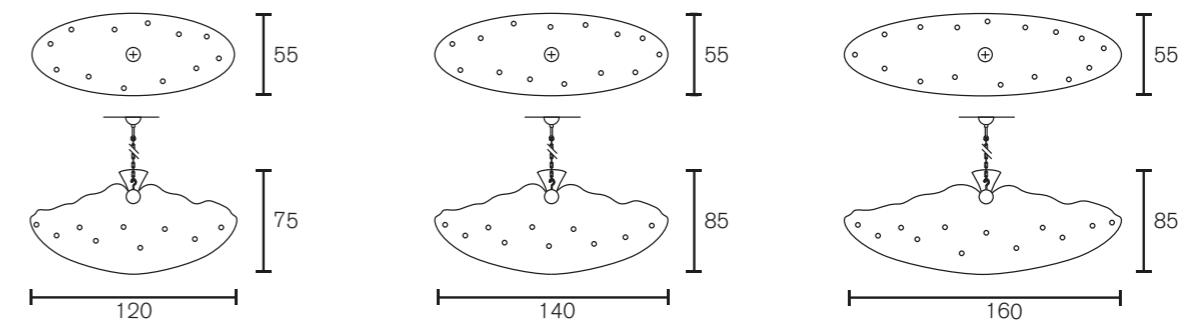

All chandeliers are supplied with 1,7 meter chain, 2 meter electrical cable and a ceiling shade.

Technical information

Ceiling Chandelier Glass

Art.nr.	Dimensions	Light bulb	Weight	Finish
HPGL40N	Ø40xH.45 cm	6x E14	15,0 kg	nickel finish
HPGL60N	Ø60xH.50 cm	8x E14	22,0 kg	nickel finish
HPGL80N	Ø80xH.55 cm	11x E14	28,0 kg	nickel finish
HPGL100N	Ø100xH.60 cm	14x E14	42,0 kg	nickel finish
HPGL120N	Ø120xH.65 cm	15x E14	60,0 kg	nickel finish

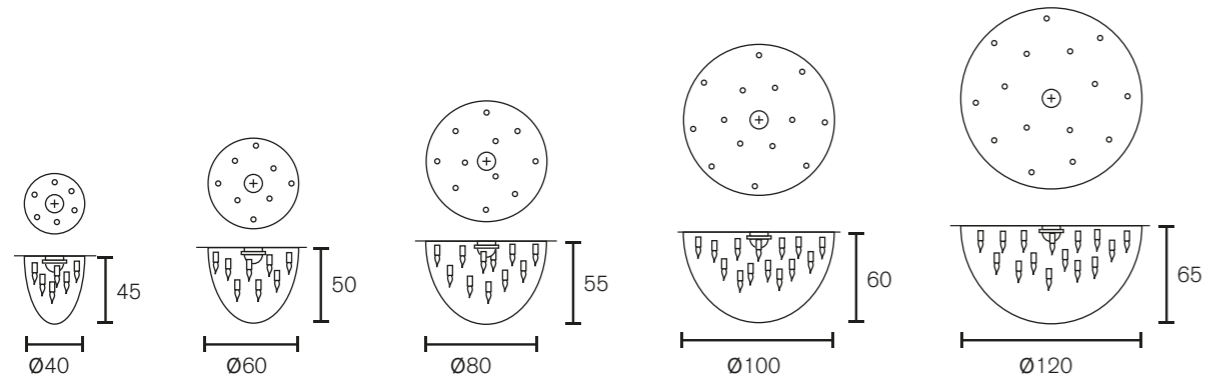

Ceiling Chandelier Glass High

Art.nr.	Dimensions	Light bulb	Weight	Finish
HPGLH60N	Ø60xH.60 cm	8x E14	23,0 kg	nickel finish
HPGLH80N	Ø80xH.80 cm	12x E14	34,0 kg	nickel finish

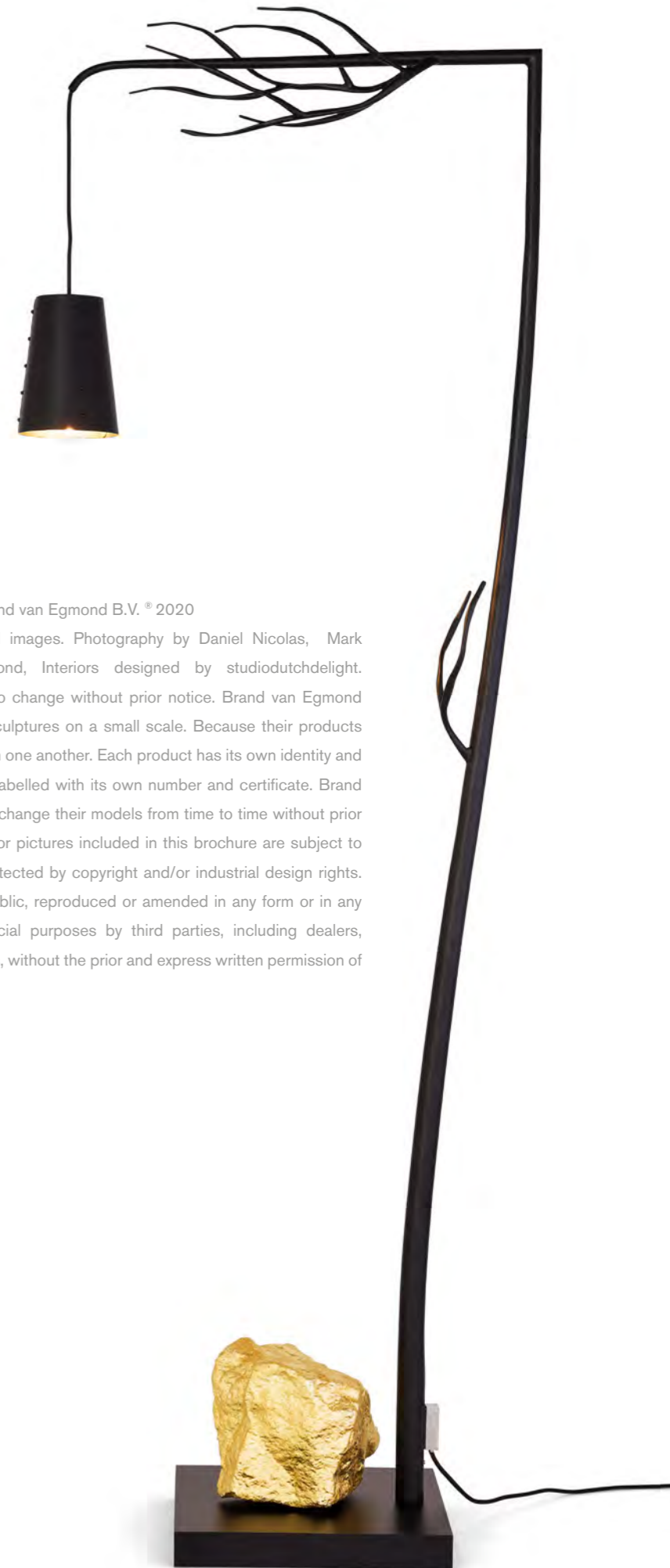
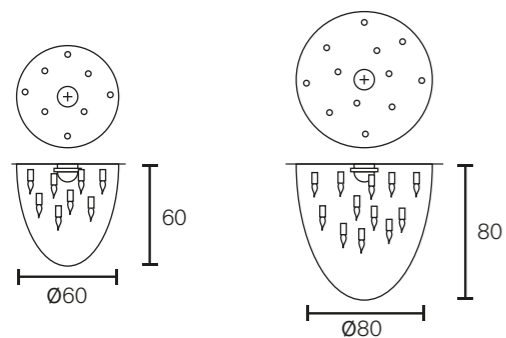

All rights reserved, copyright © Brand van Egmond B.V. © 2020

For all models, texts, layout and images. Photography by Daniel Nicolas, Mark Groeneveld and BrandvanEgmond, Interiors designed by studiodutchdelight.com. Specifications are subject to change without prior notice. Brand van Egmond manufactures exclusive lighting sculptures on a small scale. Because their products are handmade, they can differ from one another. Each product has its own identity and therefore is unique. Each item is labelled with its own number and certificate. Brand van Egmond reserves the right to change their models from time to time without prior notice. The designs, texts, layout or pictures included in this brochure are subject to errors, technical changes and protected by copyright and/or industrial design rights. No part there of may be made public, reproduced or amended in any form or in any manner whatsoever, for commercial purposes by third parties, including dealers, retailers, internet shops and others, without the prior and express written permission of the designer William Brand.



BRAND VAN EGMOND B.V. Nikkelstraat 41, 1411 AH Naarden, The Netherlands

T. +31 (0)35 692 12 59 F. +31 (0)35 691 17 25 info@brandvanegmond.com www.brandvanegmond.com

